

# Dear SHARP Customer

Welcome to the SHARP Family. We are pleased that you are now the owner of a SHARP Color LCD Projector built for outstanding quality, reliability and performance.

Every SHARP Color LCD Projector is adjusted for a proper picture and has passed through the most stringent quality control tests at the factory. We have prepared this OPERATION MANUAL so that you have the ability to adjust the picture and color to your personal viewing preference. We sincerely hope that you will be satisfied with the quality and performance of your Color LCD Projector for many years to come.

Please read the instructions carefully, and keep them handy for future reference.

## IMPORTANT

For your assistance in reporting the loss or theft of your Color LCD Projector, please record the Serial Number located on the rear of the projector and retain this information.

**Model No.: XG-E3500U**

**Serial No.:**

## Important Information

There are two important reasons for prompt warranty registration of your new SHARP LCD Projector, using the REGISTRATION CARD packed with the projector.

### 1) WARRANTY



This is to assure that you immediately receive the full benefit of the parts, service and labor warranty applicable to your purchase.

### 2) CONSUMER PRODUCT SAFETY ACT

To ensure that you will promptly receive any safety notification of inspection, modification, or recall that SHARP may be required to give under the 1972 Consumer Product Safety Act, PLEASE READ CAREFULLY THE IMPORTANT "LIMITED WARRANTY" CLAUSE. U.S.A. ONLY

**WARNING:** High brightness light source, do not stare into the beam of light, or view directly. Be especially careful that children do not stare directly into the beam of light.

**WARNING:** TO REDUCE THE RISK OF FIRE OR ELECTRIC SHOCK, DO NOT EXPOSE THIS PRODUCT TO RAIN OR MOISTURE.

 <b>CAUTION</b> RISK OF ELECTRIC SHOCK. DO NOT OPEN.		<p>The lightning flash with arrowhead symbol, within an equilateral triangle, is intended to alert the user to the presence of uninsulated "dangerous voltage" within the product's enclosure that may be of sufficient magnitude to constitute a risk or electric shock to persons.</p>
<b>CAUTION: TO REDUCE THE RISK OF ELECTRIC SHOCK, DO NOT REMOVE COVER. NO USER-SERVICEABLE PARTS INSIDE. REFER SERVICING TO QUALIFIED SERVICE PERSONNEL.</b>		<p>The exclamation point within a triangle is intended to alert the user to the presence of important operating and maintenance (servicing) instructions in the literature accompanying the product.</p>

**WARNING:** FCC Regulations state that any unauthorized changes or modifications to this equipment not expressly approved by the manufacturer could void the user's authority to operate this equipment.

U.S.A. ONLY

#### INFORMATION

This equipment has been tested and found to comply with the limits for a Class A digital device, pursuant to Part 15 of the FCC Rules. These limits are designed to provide reasonable protection against harmful interference when the equipment is operated in a commercial environment. This equipment generates, uses, and can radiate radio frequency energy and, if not installed and used in accordance with the instruction manual, may cause harmful interference to radio communications. Operation of this equipment in a residential area is likely to cause harmful interference, in which case the user will be required to correct the interference at his own expense.

U.S.A. ONLY

The enclosed RGB signal cable and Macintosh adaptor must be used with the device. The cable and adaptor are provided to ensure that the device complies with FCC Class A verification.

U.S.A. ONLY

## Important Safeguards

Electrical energy can perform many useful functions. This unit has been engineered and manufactured to ensure your personal safety. But **IMPROPER USE CAN RESULT IN POTENTIAL ELECTRICAL SHOCK OR FIRE HAZARD**. In order not to defeat the safeguards incorporated into this LCD Projector, observe the following basic rules for its installation, use and servicing. For your own protection and reliable usage of your LCD Projector, please be sure to read these "Important Safeguards" carefully before use.

- 1) Read Instructions – All the safety and operating instructions should be read before the product is operated.
- 2) Retain Instructions – The safety and operating instructions should be retained for future reference.
- 3) Heed Warnings – All warnings on the product and in the operating instructions should be adhered to.
- 4) Follow Instructions – All operating and use instructions should be followed.
- 5) Cleaning – Unplug this product from the wall outlet before cleaning. Do not use liquid cleaners or aerosol cleaners. Use a damp cloth for cleaning.
- 6) Attachments – Do not use attachments not recommended by the product manufacturer as they may cause hazards.
- 7) Water and Moisture – Do not use this product near water – for example, near a bathtub, wash bowl, kitchen sink, or laundry tub; in a wet basement; or near a swimming pool; and the like.
- 8) Accessories – Do not place this product on an unstable cart, stand, tripod, bracket, or table. The product may fall, causing serious injury to a child or adult, and serious damage to the product. Use only with a cart, stand, tripod, bracket, or table recommended by the manufacturer, or sold with the product. Any mounting of the product should follow the manufacturer's instructions, and should use a mounting accessory recommended by the manufacturer.
- 9) A product and cart combination should be moved with care. Quick stops, excessive force, and uneven surfaces may cause the product and cart combination to overturn.



- 10) Ventilation – Slots and openings in the cabinet are provided for ventilation to ensure reliable operation of the product and to protect it from overheating, and these openings must not be blocked or covered. The openings should never be blocked by placing the product on a bed, sofa, rug, or other similar surface. This product should not be placed in a built-in installation such as a bookcase or rack unless proper ventilation is provided or the manufacturer's instructions have been adhered to.
- 11) Power Sources – This product should be operated only from the type of power source indicated on the marking label. If you are not sure of the type of power supply to your home, consult your product dealer or local power company. For products intended to operate from battery power, or other sources, refer to the operating instructions.
- 12) Grounding or Polarization – This product is equipped with a three-wire grounding-type plug, a plug having a third (grounding) pin. This plug will only fit into a grounding-type power outlet. This is a safety feature. If you are unable to insert the plug into the outlet, contact your electrician to replace your obsolete outlet. Do not defeat the safety purpose of the grounding-type plug.
- 13) Power-Cord Protection – Power-supply cords should be routed so that they are not likely to be walked on or pinched by items placed upon or against them, paying particular attention to cords at plugs, convenience receptacles, and the point where they exit from the product.

- 14) Lightning – For added protection for this product during a lightning storm, or when it is left unattended and unused for long periods of time, unplug it from the wall outlet and disconnect the cable system. This will prevent damage to the product due to lightning and power-line surges.
- 15) Overloading – Do not overload wall outlets, extension cords, or integral convenience receptacles as this can result in a risk of fire or electric shock.
- 16) Object and Liquid Entry – Never push objects of any kind into this product through openings as they may touch dangerous voltage points or short-out parts that could result in a fire or electric shock. Never spill liquid of any kind on the product.
- 17) Servicing – Do not attempt to service this product yourself as opening or removing covers may expose you to dangerous voltage or other hazards. Refer all servicing to qualified service personnel.
- 18) Damage Requiring Service – Unplug this product from the wall outlet and refer servicing to qualified service personnel under the following conditions:
  - a) When the power-supply cord or plug is damaged.
  - b) If liquid has been spilled, or objects have fallen into the product.
  - c) If the product has been exposed to rain or water.
  - d) If the product does not operate normally by following the operating instructions. Adjust only those controls that are covered by the operating instructions, as an improper adjustment of other controls may result in damage and will often require extensive work by a qualified technician to restore the product to normal operation.
  - e) If the product has been dropped or damaged in any way.
  - f) When the product exhibits a distinct change in performance - this indicates a need for service.
- 19) Replacement Parts – When replacement parts are required, be sure the service technician has used replacement parts specified by the manufacturer or with the same characteristics as the original part. Unauthorized substitutions may result in fire, electric shock, or other hazards.
- 20) Safety Check – Upon completion of any service or repairs to this product, ask the service technician to perform safety checks to determine that the product is in proper operating condition.
- 21) Wall or Ceiling Mounting – The product should be mounted to a wall or ceiling only as recommended by the manufacturer.
- 22) Heat – The product should be situated away from heat sources such as radiators, heat registers, stoves, or other products (including amplifiers) that produce heat.

## Cautions Concerning the Laser Pointer

<b>CAUTION</b>	"COMPLIES WITH 21 CFR SUBCHAPTER J" SHARP ELECTRONICS CORPORATION SHARP PLAZA, MAHWAH, NEW JERSEY 07430 TEL : 1-800-BE-SHARP <span style="float: right;">[U.S.A. ONLY]</span>	
LASER RADIATION- DO NOT STARE INTO BEAM WAVE LENGTH : 670nm MAX. OUTPUT : 1mW CLASS II LASER PRODUCT	REMOTE CONTROL MODEL NO. : RRMCG1392CESA DC6V (1.5VX4PCS.) MADE IN JAPAN FABRIQUÉ AU JAPON	



The laser pointer on the remote control emits a laser beam from the laser light window shown in the figure to the left. The laser emitted is a class II laser; therefore, do not look into the laser window or shine the laser beam on yourself or other people. The three marks to the left are the caution labels for the laser beam. Always use the laser pointer at temperatures between 41°F and 104°F (+5°C and +40°C).

**AVOID EXPOSURE-LASER RADIATION IS EMITTED FROM THIS APERTURE.**

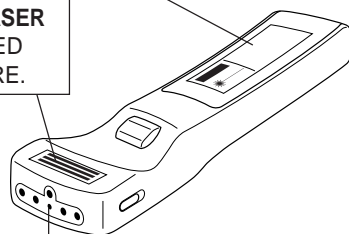

LASER LIGHT WINDOW

**Caution:** Use of controls or adjustments or performance of procedures other than those specified herein may result in hazardous radiation exposure.

# Notes on Operation

## About the Temperature Monitor Function:

- If the projector starts to overheat due to set-up problems or a dirty air filter, "TEMP." will flash in the upper-left corner of the picture. If the temperature continues to rise, then the lamp will turn off, the TEMPERATURE WARNING indicator will flash, and after a 90-second cooling-off period the power will shut off. Refer to page 32, "Maintenance Indicators," when the "TEMP." warning appears in the picture.

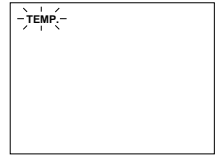

## About the Lamp Monitor Function:

- When the projector is turned on after the lamp has been in use for more than 1,400 hours, the yellow "LAMP" display will flash on the screen for 60 seconds, as shown on the right. This is to alert you that it is time to replace the lamp. At this point, take your projector to the nearest Authorized Sharp Industrial LCD Products Dealer or Service Center to have the lamp replaced.
- If the lamp is used for more than 1,500 hours, the projector power will automatically turn off, and the projector will be in STANDBY mode.
- Refer to page 32, "Maintenance Indicators," when the "LAMP" display warning appears.

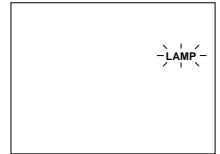

**Caution:** If "LAMP" begins to flash on the screen, be sure to take your projector to the nearest Authorized Sharp Industrial LCD Products Dealer or Service Center to have the lamp replaced.

# Outstanding Features

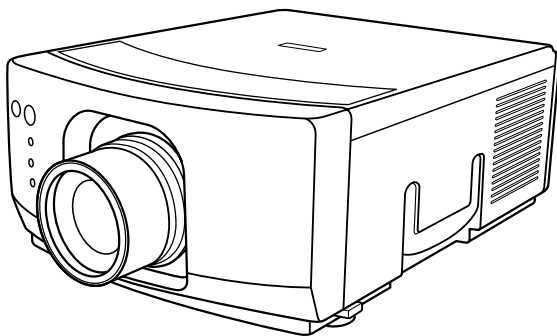

Allows easy projection of large screen, full-color computer and video images.

- Can be projected directly onto a video screen or white wall.
- Lightweight, convergence-free system for easy installation.

## DIRECT COMPUTER COMPATIBILITY

A multi-scan RGB Input accepts signals from SXGA (1,280 dots × 1,024 lines compressed), XGA (1,024 dots × 768 lines), SVGA (800 dots × 600 lines), VGA and Mac (1,024 dots × 768 lines maximum) compatible computers without the need for any additional hardware.

## FLEXIBLE USE

In addition to the standard front projection mode, the menu driven functions can be used to instantly reverse the image for rear projection, and invert the image for ceiling mounting.

## POWER ZOOM AND FOCUS

- Provides simple screen-size adjustments from either the projector or the remote control.
- Screen projection size adjusts from 40 to 500 inches.

## LENS SHIFT

The lens can be easily raised and lowered to minimize or eliminate "Keystone" type effects.

## HIGH PICTURE QUALITY

The three LCD panels contain 786,432 × RGB pixels to achieve exceptionally bright, high quality video images with up to 520 scan doubled TV lines of resolution (700 lines for S-video).

## VERSATILE REMOTE CONTROL

- Built-in wireless mouse allows simultaneous operation of projector and computer.
- Built-in Laser Pointer for professional presentations.

## BUILT-IN STEREO SPEAKERS

Built in 3 W + 3 W stereo amplifiers and speakers eliminate the need for external audio components.

## USE WITH "PLUG AND PLAY"

"Plug and play" compatible with VESA DDC 1 and DDC 2B standards.

# Location of Controls

## FRONT VIEW

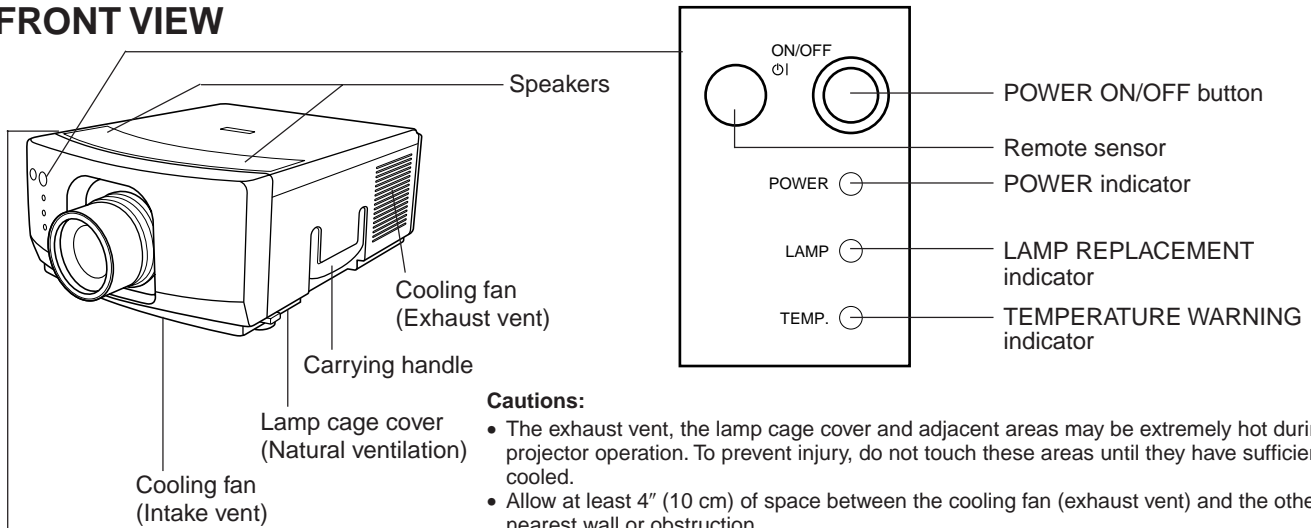

### Cautions:

- The exhaust vent, the lamp cage cover and adjacent areas may be extremely hot during projector operation. To prevent injury, do not touch these areas until they have sufficiently cooled.
- Allow at least 4" (10 cm) of space between the cooling fan (exhaust vent) and the other nearest wall or obstruction.
- If the cooling fan becomes obstructed, a protection device will automatically turn off the projector lamp. This does not indicate a malfunction. Remove the projector plug from the wall outlet and wait 10 minutes. Then turn on the power by plugging the cord back in. This will return the projector to its normal mode.

## OPERATION PANEL ON SIDE OF PROJECTOR

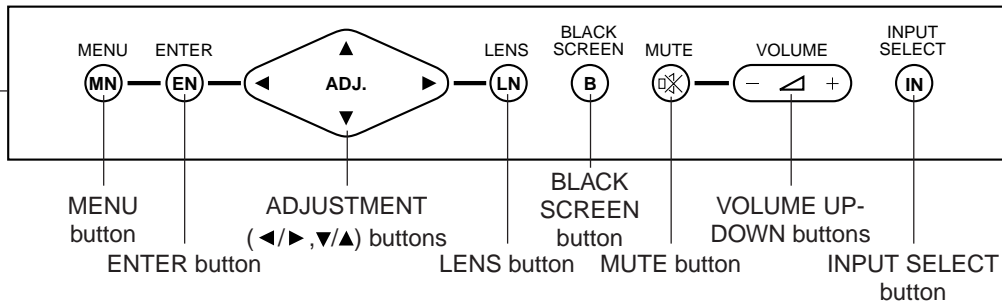

## SIDE AND REAR VIEW

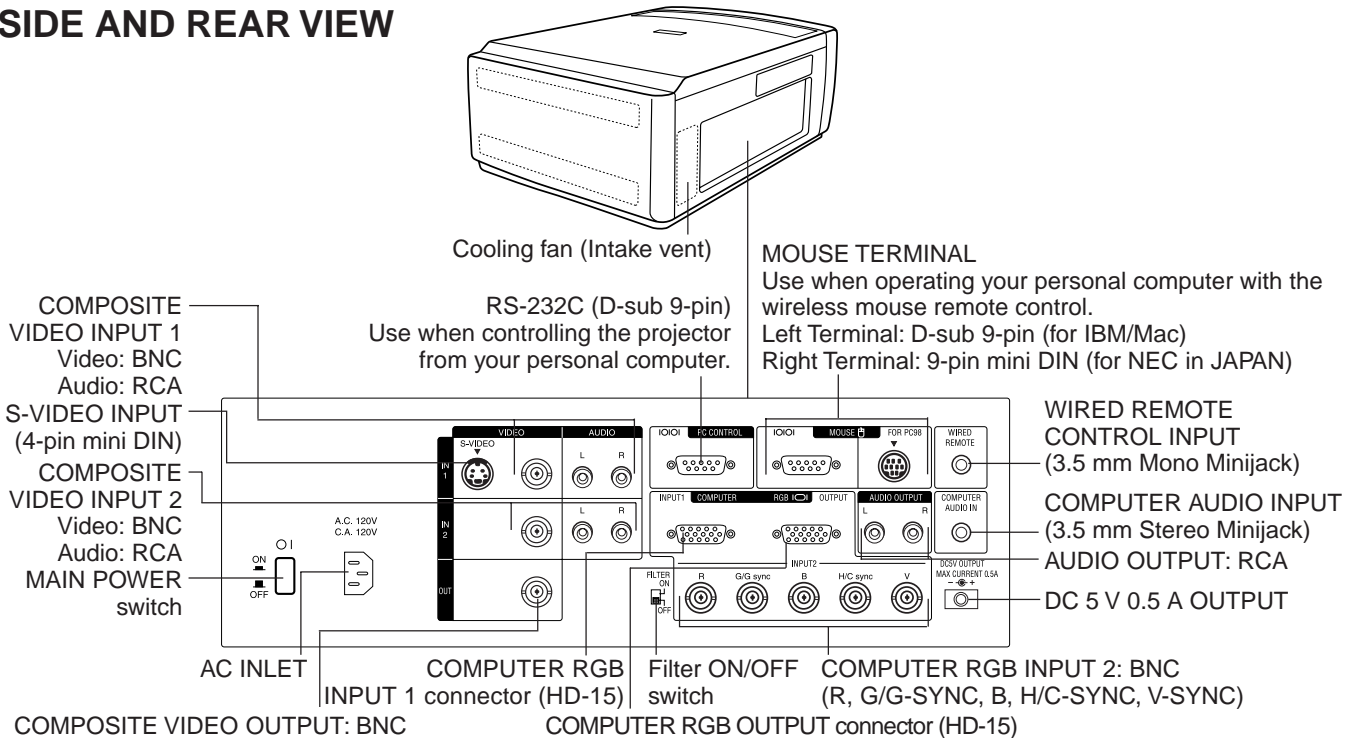

### Notes:

- The DC 5 V OUTPUT jack cannot supply a current of more than 0.5 A.
- When connecting a Macintosh Series computer that outputs C-SYNC, connect the cable to the COMPUTER RGB 2 INPUT H-SYNC input terminal.



# Operating the Wireless Mouse Remote Control

The functions of your personal computer's mouse have been built into the remote control enabling you to operate your projector and personal computer with only the remote control.

1. Slide the MAIN POWER switch on the side of the unit on.
2. Press the POWER ON button on the front panel of the remote control to turn the projector power on.
3. When using the remote control as a wireless mouse, move the MOUSE/ADJUSTMENT sliding switch to the MOUSE position. When using the remote control to operate the projector, move the MOUSE/ADJUSTMENT sliding switch to the ADJ. position. To activate the remote control key back-light feature, press the LIGHT button on the remote control. The colors of the buttons will change as shown in the table at the bottom of this page.

## Wireless Mouse Remote Control

### FRONT VIEW

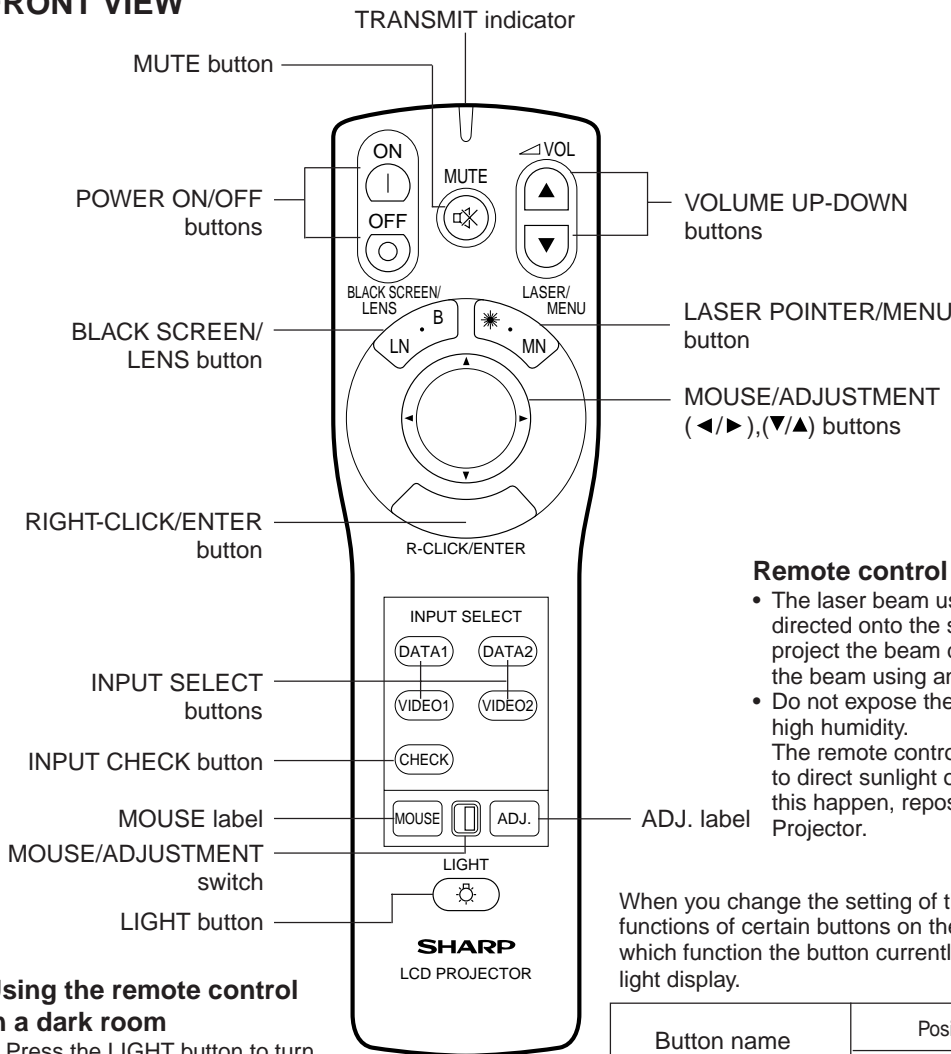

### SIDE VIEW

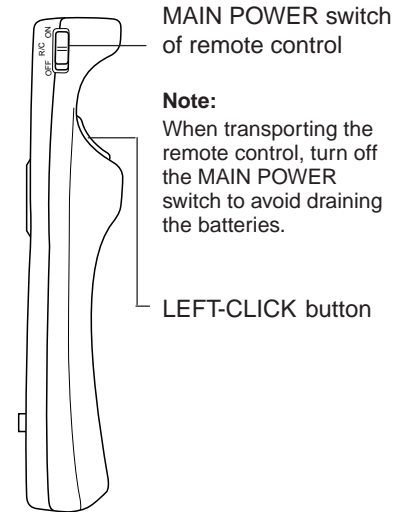

### Using the remote control in a dark room

- Press the LIGHT button to turn on the back-lights for the operation buttons for about 5 seconds. The back-light colors are explained in the table to the right.

#### Note:

- If the MAIN POWER switch on the remote control is left on for more than 10 minutes without operation, the power will automatically turn off. To turn the power back on, press any button on the remote control for at least one second.

### Remote control handling precautions

- The laser beam used in this product is harmless when directed onto the skin, however please be careful not to project the beam directly into the eyes. Do not stare into the beam using an optical instrument.
- Do not expose the remote control to shocks, liquids or high humidity. The remote control may not operate normally if exposed to direct sunlight or other intense light sources. Should this happen, reposition the light source or the LCD Projector.

When you change the setting of the MOUSE/ADJUSTMENT switch, the functions of certain buttons on the remote control change. You can tell which function the button currently possesses by the color of its back-light display.

Button name	Position of MOUSE/ADJUSTMENT switch	
	MOUSE	ADJ.
LASER POINTER/MENU	LASER POINTER (GREEN)	MENU (RED)
RIGHT-CLICK/ENTER	RIGHT-CLICK (GREEN)	ENTER (RED)
MOUSE/ADJUSTMENT	MOUSE (NOT LIT)	ADJ. </>, </> (NOT LIT)
LEFT-CLICK	ON (NOT LIT)	—
BLACK SCREEN/LENS	BLACK SCREEN (GREEN)	LENS (RED)
POWER ON/OFF	ON (RED)	
VOLUME UP-DOWN		
MUTE		
VIDEO 1		
VIDEO 2		
DATA 1		
DATA 2		
INPUT CHECK		

## TOP VIEW

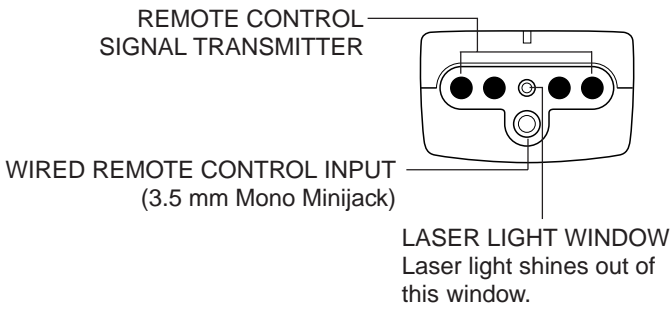

## Using the optional cable with the remote control

- When the remote control cannot be used due to the range or positioning of the projector (rear projection, etc.), connect the optional cable from the Wired Remote Control Input jack on the remote control to the Wired Remote Input on the side of the projector.

### Note:

- The signal transmitter does not function when the optional cable is connected to the remote control.

<p><b>CAUTION</b></p> <p>LASER RADIATION- DO NOT STARE INTO BEAM</p>  <p>WAVE LENGTH : 670nm MAX. OUTPUT : 1mW CLASS II LASER PRODUCT</p>	<p>"COMPLIES WITH 21 CFR SUBCHAPTER J"</p> <p>SHARP ELECTRONICS CORPORATION SHARP PLAZA, MAHWAH, NEW JERSEY 07430 TEL : 1-800-BE-SHARP [U.S.A. ONLY]</p>
	<p>REMOTE CONTROL MODEL NO. : RRMCG1392CESA DC6V (1.5VX4PCS.) MADE IN JAPAN FABRIQUÉ AU JAPON</p>



The laser pointer on the remote control emits a laser beam from the laser light window shown in the figure to the left. The laser emitted is a class II laser; therefore, do not look into the laser window or shine the laser beam on yourself or other people. The two marks to the left are the caution labels for the laser beam.

Always use the laser pointer at temperatures between 41°F and 104°F (+5°C and +40°C).

## REAR VIEW

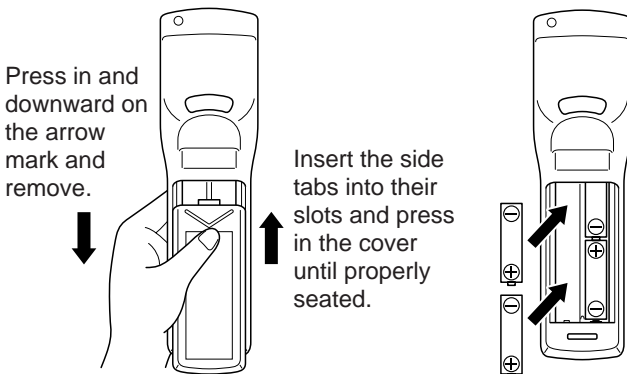

## Inserting the Batteries

Remove the battery cover as shown and insert four AA size batteries making sure their polarities match the (+) and (-) marks inside the battery compartment.

### Notes:

Incorrect use of batteries may cause them to leak or burst.

- Insert the batteries with the (+) and (-) polarities as indicated.
- Remove the batteries if the remote control will not be operated for an extended period of time.
- Maintain the batteries in a clean condition.
- Do not mix different brands of batteries. The life expectancy of the new batteries will be shortened and the old batteries may leak.
- When the batteries have been used up, remove them immediately to prevent leakage and damage. Leaked battery fluid may irritate the skin. Remove any battery fluid by wiping with a cloth.
- Due to storage conditions and the shelf life of the supplied batteries, they may run out after a short time. If so, replace them with new batteries as soon as possible.

## Remote control positioning

Use the remote control as shown in the figures on the left.

### Note:

- The signal from the remote control can be reflected off the screen for easy operation. However, the effective distance of the signal may differ due to the screen material.

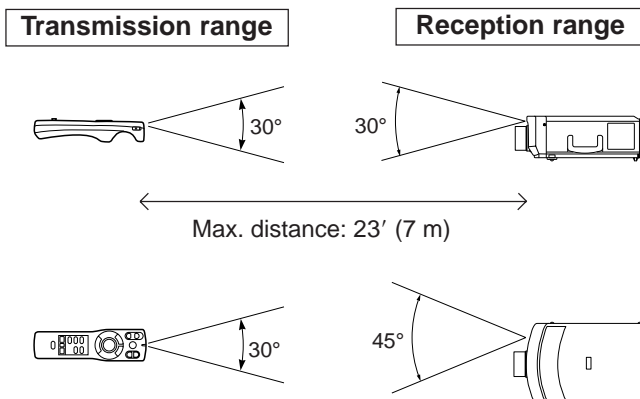

# Wireless Mouse Functions

- The wireless mouse functions and laser pointer on the remote control can help you create a more professional presentation.
- By attaching the provided mouse cable to both the mouse terminal on your projector and the mouse terminal on your personal computer, you can use the wireless mouse built into the remote control, instead of the mouse equipped with your personal computer, to operate your personal computer. The wireless mouse functions will work with personal computers compatible with IBM PS/2, serial (RS-232C) or Apple ADB type mouse systems.

## Connection Example

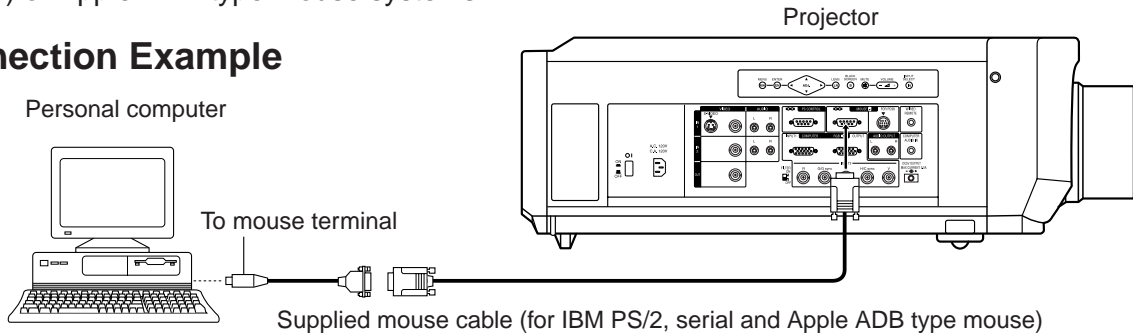

## Functions and Operations

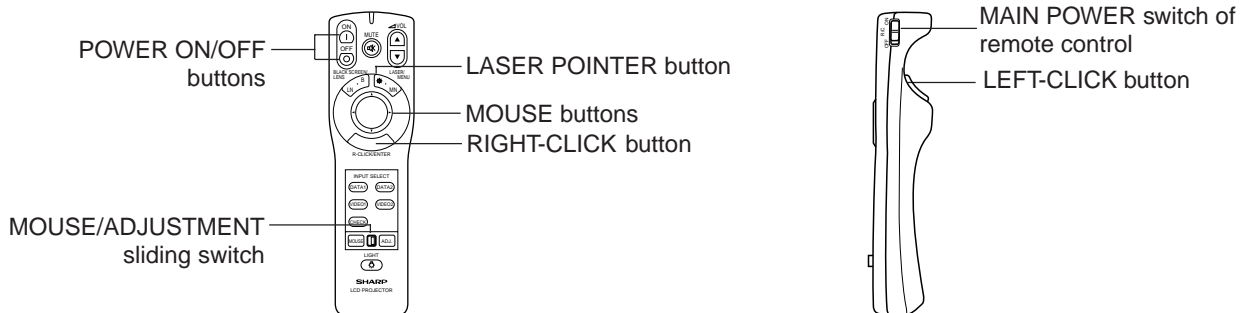

- First, connect the units as shown above, and turn the projector power on.
- Second, turn the computer power on.
- Next, slide the MAIN POWER switch on the side of the remote control.
- When using the remote control as a wireless mouse, move the MOUSE/ADJUSTMENT sliding switch to the MOUSE position.

### Notes:

- In some situations the wireless mouse may be inoperable if your computer port is not correctly set-up. Please refer to your computer owners manual for details on setting-up/installing the correct Mouse Driver.
- Do not connect or remove the mouse control cable to/from your computer while it is on. This may damage your computer.
- Do not connect the mouse input terminal for IBM/Mac and the mouse input terminal for PC98 simultaneously.

## MOUSE buttons

By lightly pressing the up/down and right/left arrow buttons located on the front of the remote control, you can move the mouse cursor on your monitor screen.

**Note:** The amount of pressure applied to the MOUSE button determines the speed the mouse cursor travels. Pressing lightly on the periphery of the MOUSE button makes the mouse cursor move slowly. Pressing hard makes it move quickly.

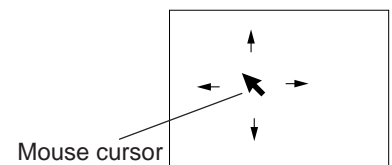

### LEFT-CLICK button

The LEFT-CLICK button on the back of the remote control corresponds to the left button of the mouse on two-button mouse systems.

### RIGHT-CLICK button

The RIGHT-CLICK button on the front of the remote control corresponds to the right button on two-button mouse systems.

**Note:** For one-button mouse systems use either the LEFT-CLICK or RIGHT-CLICK button.

### LASER POINTER button

Press the LASER POINTER button to activate the laser pointer.

When the button is pressed, the light stays on; when the button is released, the light goes off. However, even when the button is pressed continuously, the light automatically goes off 1 minute after it goes on. To turn it on again press the laser pointer button one more time.

<p><b>CAUTION</b></p> <p>LASER RADIATION- DO NOT STARE INTO BEAM</p> <p>WAVE LENGTH : 670nm MAX. OUTPUT : 1mW CLASS II LASER PRODUCT</p>	<p>"COMPLIES WITH 21 CFR SUBCHAPTER J"</p> <p>SHARP ELECTRONICS CORPORATION SHARP PLAZA, MAHWAH, NEW JERSEY 07430 TEL : 1-800-BE-SHARP [U.S.A. ONLY]</p>
	<p>REMOTE CONTROL MODEL NO. : RRMCG1392CESA DC6V (1.5Vx4PCS.) MADE IN JAPAN FABRIQUÉ AU JAPON</p>



The laser pointer on the remote control emits a laser beam from the laser light window. The laser emitted is a class II laser; therefore, do not look into the laser window or shine the laser beam on yourself or other people. The two marks to the left are the caution labels for the laser beam.

Always use the laser pointer at temperatures between 41°F and 104°F (+5°C and +40°C).



# Setting Up the Projector

## Using the Focus, Zoom and Lens Shift

- Lens Shift, Zoom, Focus and Reversed/Inverted Image mode functions broaden your options for projector placement.
- See pages 10, 12 and 13 for details on projector setup.

### SIDE VIEW

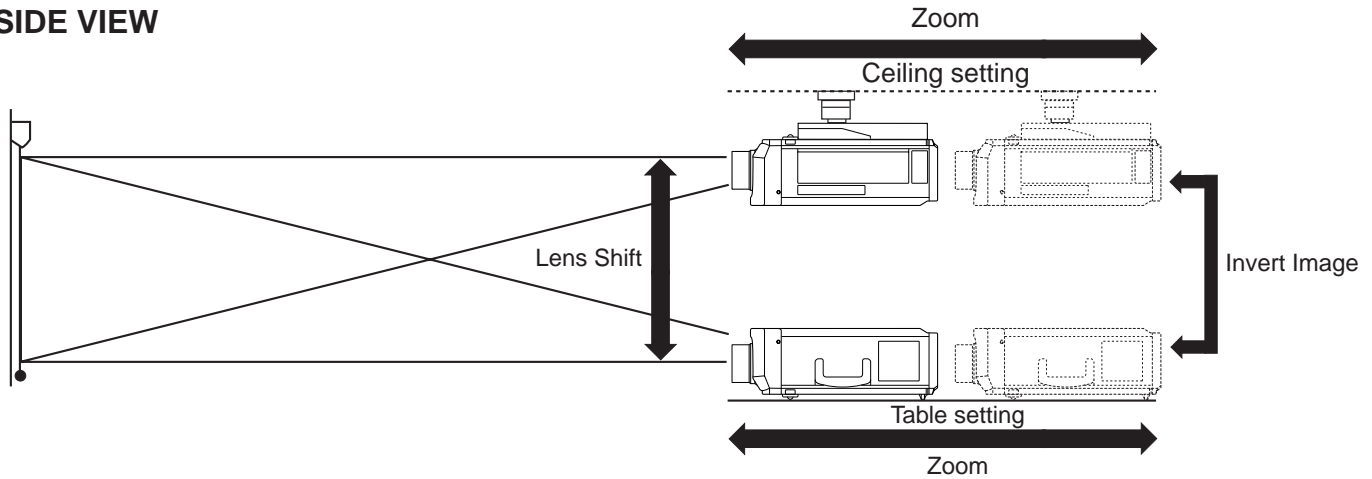

### 1. Turn on the MAIN POWER.

Turn on the MAIN POWER switch on the side of the projector.

2

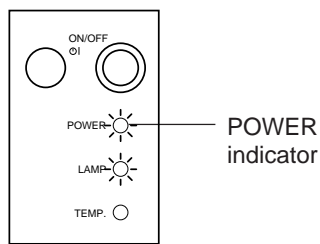

### 2. Turn on the POWER.

Press the POWER ON/OFF button on the projector or the POWER ON button on the remote control to turn on the power.

3

### FOCUS

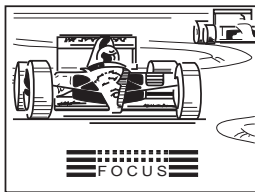

SHIFT

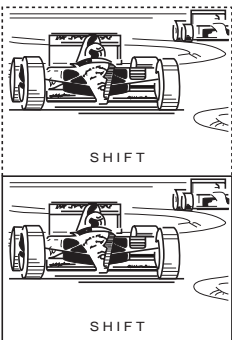

ZOOM

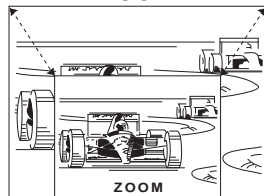

### 3. Press the LENS button.

- When using the remote control to adjust the picture, move the MOUSE/ADJUSTMENT sliding switch to the ADJUSTMENT position. When the LENS button on the remote control or on the projector is pressed, the LENS adjustment mode is indicated for about 8 seconds.
- If the LENS button is pressed while the mode is indicated on the screen, the picture adjustment mode changes as shown on the left.
- You can adjust the picture as shown on the left by pressing the ADJUSTMENT (◀) or (▶) buttons for FOCUS and ZOOM or the ADJUSTMENT (▲) or (▼) buttons for SHIFT while in ADJUST mode.

#### Note:

- Do not attempt to adjust the lens by hand as it may damage the lens mechanism.
- Adjust the focus until the picture on the screen is sharp.
- The focus pattern appears on the screen.
- The picture can be adjusted to the desired size within the zoom lens range.
- The picture can be adjusted within the shift range of the lens.

# Projector Distance and Picture Size Relationship

- The motorized zoom lens allows adjustment to the image size within the projector's range.
- The picture can be focused from a minimum of approximately 4.5 ft (1.4 m) to a maximum of 96.3 ft (29.4 m) from the screen. Please set up the projector within this range.

## Distance from screen

Picture size: 100 inches (254 cm)

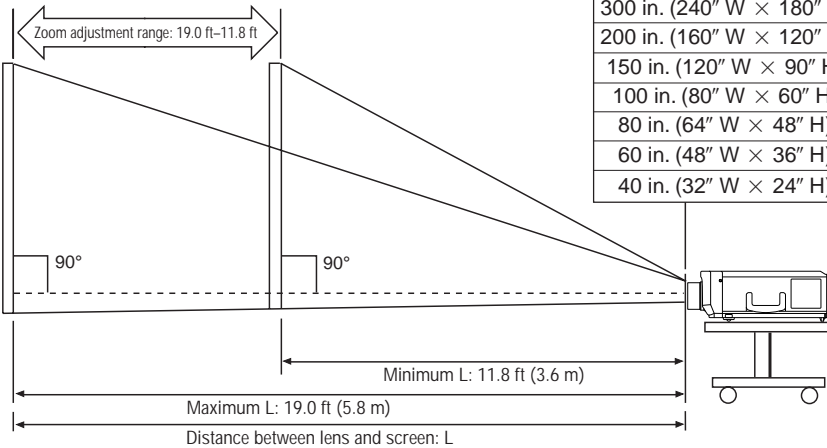

Picture size (diag.)	Projection distance (L)	
	Maximum projection distance	Minimum projection distance
500 in. (400" W × 300" H)	96.3 ft (29.4 m)	60.5 ft (18.4 m)
400 in. (320" W × 240" H)	77.0 ft (23.5 m)	48.3 ft (14.7 m)
300 in. (240" W × 180" H)	57.7 ft (17.6 m)	36.1 ft (11.0 m)
200 in. (160" W × 120" H)	38.3 ft (11.7 m)	23.9 ft (7.3 m)
150 in. (120" W × 90" H)	28.6 ft (8.7 m)	17.9 ft (5.5 m)
100 in. (80" W × 60" H)	19.0 ft (5.8 m)	11.8 ft (3.6 m)
80 in. (64" W × 48" H)	15.1 ft (4.6 m)	9.3 ft (2.9 m)
60 in. (48" W × 36" H)	11.2 ft (3.4 m)	6.9 ft (2.1 m)
40 in. (32" W × 24" H)	7.3 ft (2.2 m)	4.5 ft (1.4 m)

The formula for picture size and projection distance  
 $y_1 = (0.059x - 0.1175) \times 3.28$   
 $y_2 = (0.0371x - 0.1211) \times 3.28$   
 $x$  : Picture size (diag.) (inches)  
 $y_1$  : Maximum projection distance (ft)  
 $y_2$  : Minimum projection distance (ft)

**Note:** There is an error of ± 4 inches (± 10 cm) in the formula above.

Diagram shows the lens shift position set at the factory.

- Above is an illustration of maximum and minimum projection distances for the XG-E3500U with a picture size of 100 inches (254 cm). Move the projector forward or back if the edges of the image are distorted.

## Height of Projector

- This projector is equipped with a lens shift function that lets you adjust the projection height without moving the projector.
- Adjust to match the setup configuration.

Picture size (diag.)	Distance from lens center to lower edge of screen (H)	
	Lower lens shift position	Upper lens shift position
500 in. (400" W × 300" H)	- 25.4 in. (- 64.6 cm)	242.2 in. (615.1 cm)
400 in. (320" W × 240" H)	- 20.4 in. (- 51.7 cm)	193.7 in. (492.1 cm)
300 in. (240" W × 180" H)	- 15.3 in. (- 38.8 cm)	145.4 in. (369.2 cm)
200 in. (160" W × 120" H)	- 10.2 in. (- 25.8 cm)	96.9 in. (246.1 cm)
150 in. (120" W × 90" H)	- 7.6 in. (- 19.4 cm)	72.7 in. (184.6 cm)
100 in. (80" W × 60" H)	- 5.1 in. (- 12.9 cm)	48.5 in. (123.1 cm)
80 in. (64" W × 48" H)	- 4.1 in. (- 10.3 cm)	38.8 in. (98.5 cm)
60 in. (48" W × 36" H)	- 3.1 in. (- 7.8 cm)	29.1 in. (73.9 cm)
40 in. (32" W × 24" H)	- 2.0 in. (- 5.2 cm)	19.4 in. (49.3 cm)

Picture size: 100 inches (254 cm)

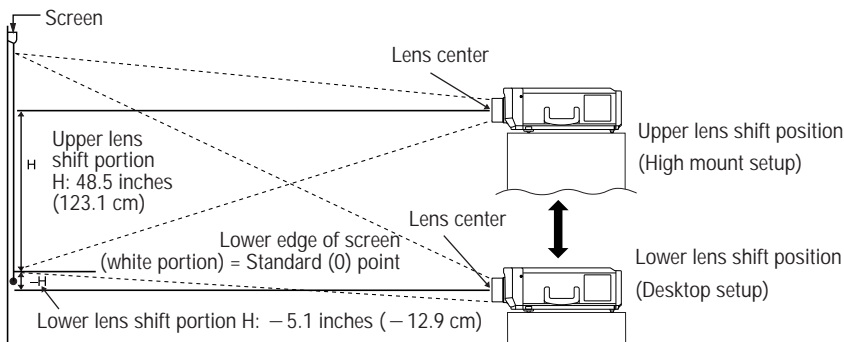

### • Ceiling Mount

When the projector is in the inverted position, use the upper edge of the screen as the base line, and exchange the lower and upper lens shift values.

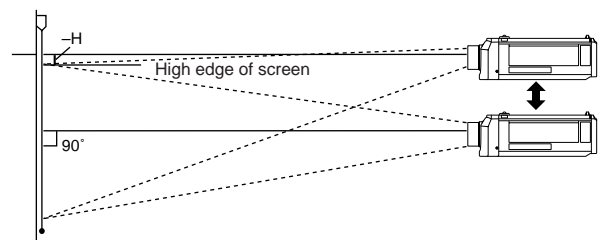

### **Note:**

- Optimal image quality is produced with the projector positioned perpendicular to the screen with all feet flat and level. Tilting or angling the projector will reduce the effectiveness of the lens shift function.

# Using the Image Invert/Reverse Function

■ This projector is equipped with an image invert/reverse function. The projected image can be inverted or reversed by using the MENU button and the ADJUSTMENT ▼/▲ and ◀/▶ buttons.

1

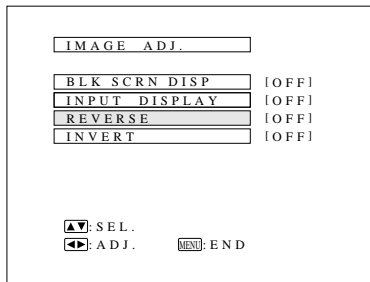

## 1. Press the MENU button.

With the MENU screen displayed, press the ADJUSTMENT ▼/▲ buttons to select "IMAGE ADJ.". Then press the ENTER button to display the IMAGE ADJ. screen.

- The last MENU screen selected is indicated for about 30 seconds.

2

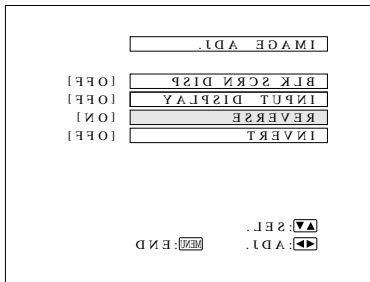

## 2. Reversed Image Mode

In the IMAGE ADJ. menu, press the ADJUSTMENT ▼/▲ buttons to select "REVERSE". Then press the ADJUSTMENT ◀/▶ buttons to select ON. The reversed image will appear.

3

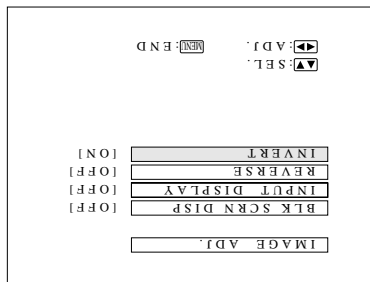

## 3. Inverted Image Mode

In the IMAGE ADJ. menu, press the ADJUSTMENT ▼/▲ buttons to select "INVERT". Then press the ADJUSTMENT ◀/▶ buttons to select ON. The inverted image will appear.

4

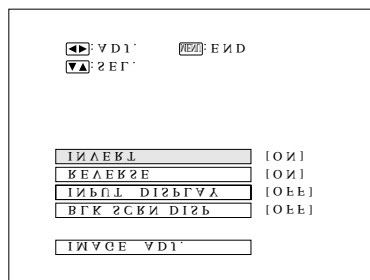

## 4. Reversed Inverted Image Mode

In the IMAGE ADJ. menu, set the REVERSE and INVERT functions to ON. The reversed inverted image will appear.

## 5. Press the MENU button anytime to exit IMAGE ADJ.

## How to set up the projector and screen

### Cautions: When setting up the projector

- For minimal servicing and to maintain high image quality, SHARP recommends that this projector be installed in an area free from humidity, dust and cigarette smoke. When the projector is subjected to these environments, the lens and filter must be cleaned more often. Periodically the filter should be replaced and the projector should be cleaned internally. As long as the projector is properly maintained in this manner, use in these environments will not reduce the overall operation life. Please note that all internal cleaning must be performed by an Authorized Sharp Industrial LCD Products Dealer or Service Center.
- Do not expose to extreme heat or cold.  
Operating temperature: 41°F to 104°F (+5°C to +40°C)  
Storage temperature: -4°F to 140°F (-20°C to +60°C)
- Do not tilt the projector more than 5°.

- Position the screen so that it is not in direct sunlight or room light. Light falling directly onto the screen washes out colors, making viewing difficult. Close the curtains and dim the lights when using the screen in a bright or sunny room.
- The best picture will be obtained when the projector is at a 90 degree angle to the screen. Position the projector and screen as shown.

### Example of a standard setup

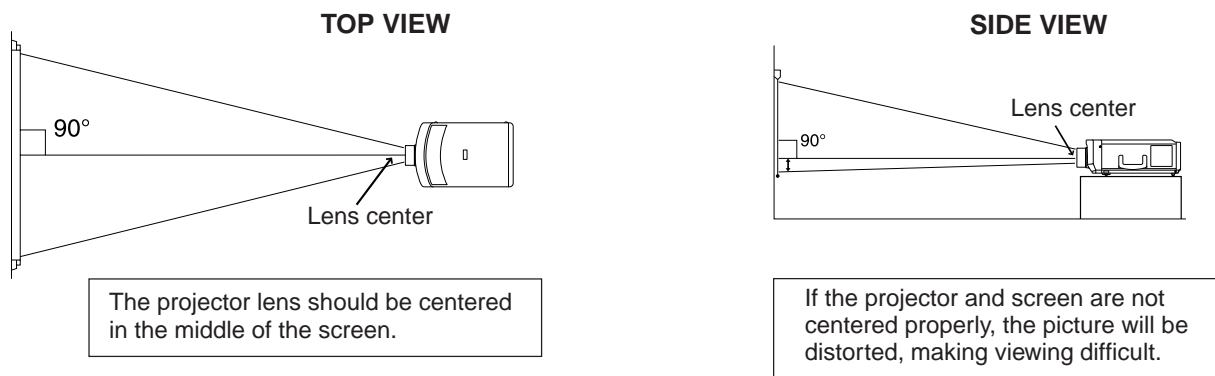

- Using the horizontal reverse function makes the following setups possible.

### Example of a reversed image setup

- By placing a mirror (normal flat type) in front of the lens and using the horizontal reverse function, the image reflected from the mirror can be projected onto the screen.
- Rear projection with a rear projection screen is also possible when using the horizontal reverse function.

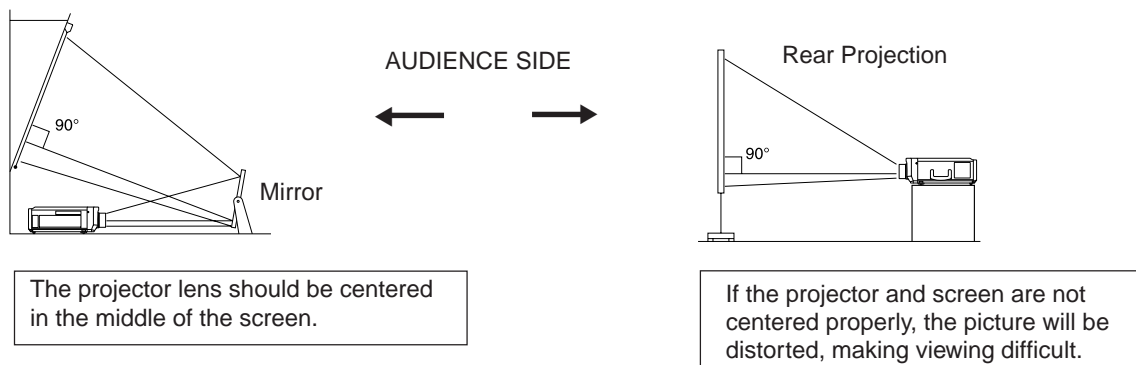

## Example of a high-mount setup

- A high-mount setup makes projection from an elevated location possible, without ceiling modifications.

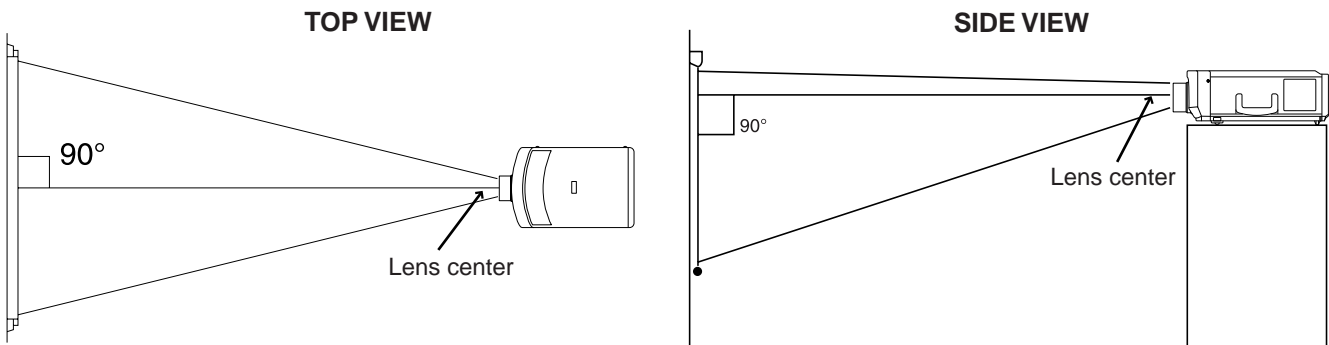

## Example of a ceiling-mount setup

Before mounting the projector, be sure to contact your nearest Authorized Sharp Industrial LCD Products Dealer to obtain the manufacturer recommended ceiling mount bracket (sold separately). (AN-XGCM20 Ceiling Mount Bracket, AN-EP101AP Extension Tube).

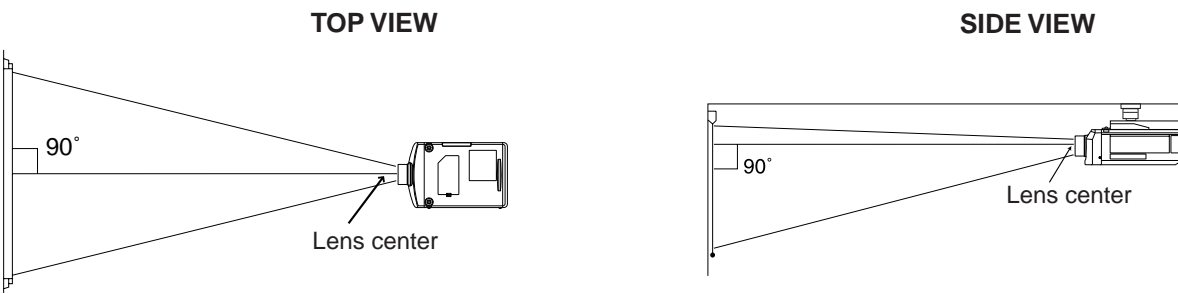

- If the relative positions of the projector and the screen are not properly adjusted, the picture will be distorted.

### Note:

- A polarizing screen cannot be used with this projector.

## Inverted Labeling for Ceiling Mount

- When ceiling mounting the projector, attach the supplied inverted label as shown.

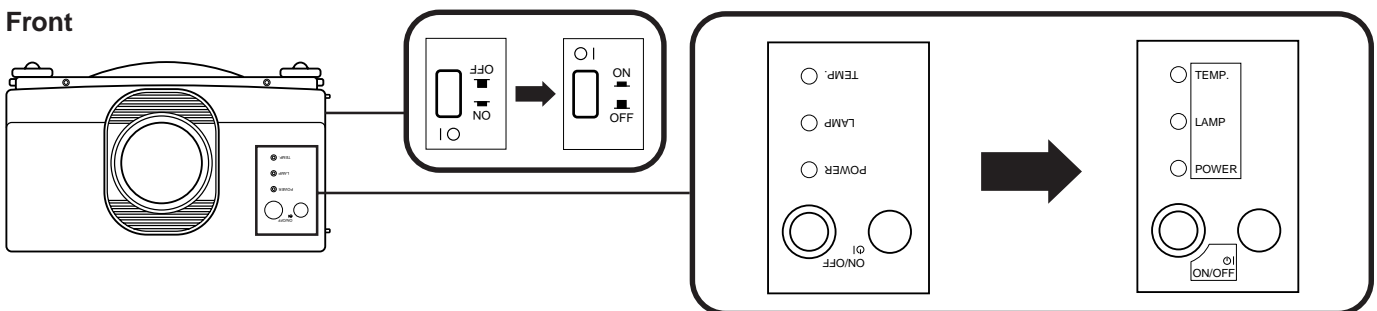

## Terminal Cover

- When the projector is ceiling mounted, attach the terminal cover (supplied) to hide the connecting cables.
- Use the terminal cover to hide the connecting cables when the projector is used on a desktop or high mounted.

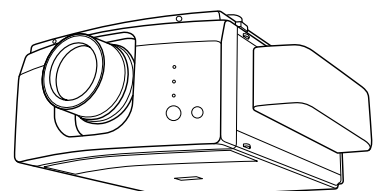



## Adjusting the Height of the Picture

- When adjustments for the projector position cannot be made using the Lens Shift alone, or when the projector stand is on an angle, use the adjuster release to adjust the vertical angle of the projector. Minor adjustments can be made with the adjusters.

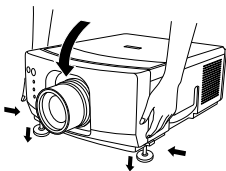
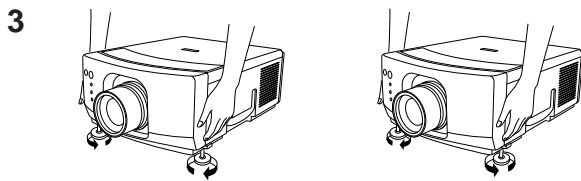
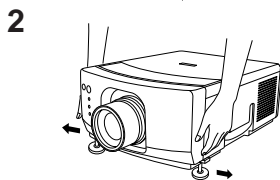
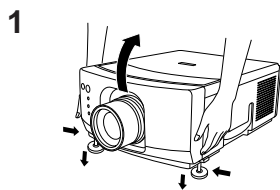
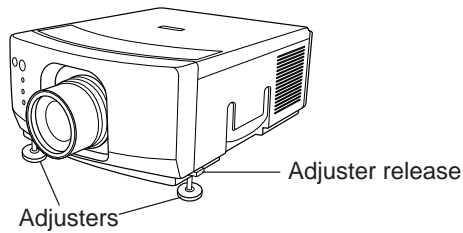

1. **Press the adjuster release and lift the projector to the desired angle with both hands.**

- The adjuster legs will extend to the surface of the table.

2. **Remove your hand from the adjuster release.**

- The adjuster legs will lock in position. Release the projector once you are sure the adjuster legs have locked in position.

3. **Make any minor adjustments necessary.**

- Turn the adjusters to further adjust the angle of the projector.

### Returning the projector to its original position

- While holding the projector with both hands, press the adjuster release and slowly lower the projector to its original position.

### Notes:

- Adjustable up to approximately 5° from the horizontal.
- When adjustments are made with the adjusters, the picture may become distorted, depending on the relative positions of the projector and the screen.
- After adjusting, in some cases, all of the adjuster legs may not be resting on the table.  
To prevent the projector from wobbling, adjust the adjuster legs so that they firmly contact the table.

### Cautions:

- Do not press the adjuster release when the adjuster legs are extended without firmly holding the projector.
- When lowering the projector, be careful not to get your fingers caught in the area between the adjusters and the projector.
- Do not hold the lens when lifting or lowering the projector.

## Transporting the Projector

Use the carrying handle when carrying the projector.

When transporting the projector, carry it by the handle located on the side of the unit.

### Note:

- Always put on the lens cap to prevent damage to the lens when transporting the projector.

### Caution:

- Do not lift or carry the projector by the lens or the lens cap as this may damage the lens.

Carrying handle



# Connecting the Projector (VIDEO 1, VIDEO 2)

- To watch video playback with the projector connected to audio/video output equipment, such as a VCR, or Laser Disc Player or DVD Player or to view on a separate monitor, make the following connections.
- Always turn off the LCD Projector while connecting to video equipment, in order to protect both the projector and the equipment being connected.

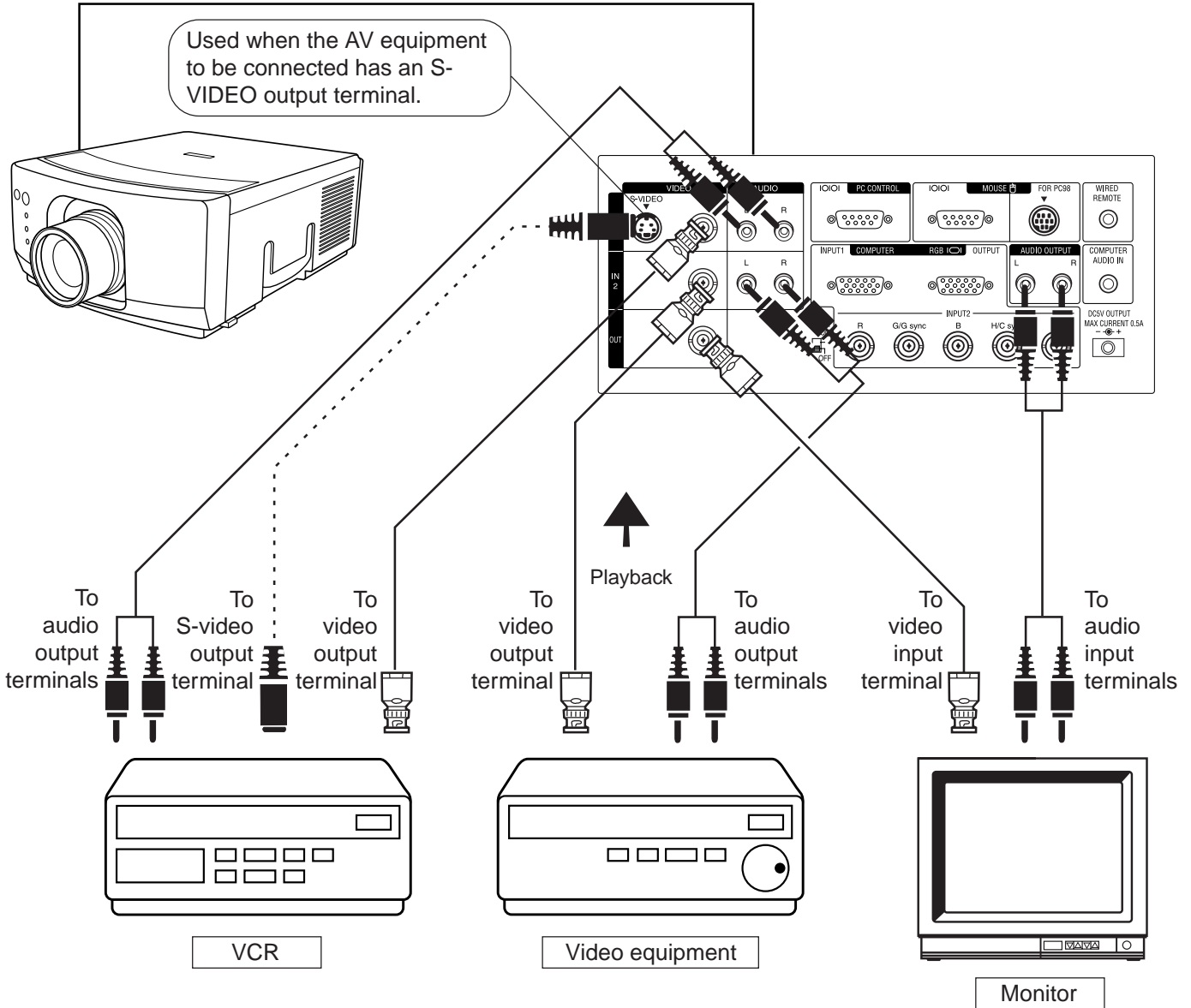

- Select either VIDEO 1 or VIDEO 2 to output the images to the monitor.
- Note the following when using the S-VIDEO INPUT terminal:
  - The S-VIDEO INPUT terminal uses a video signal system in which the picture is separated into a color and a luminance signal to realize a higher-quality picture.
  - The S-VIDEO INPUT terminal has priority over the VIDEO INPUT 1 terminal. Make the audio connection via the AUDIO INPUT terminals (left/right).

# Connecting the Projector (RGB 1, 2: Computer)

- Please carefully read the manual of the computer you will be connecting.
- Before connecting, be sure to turn both the projector and the computer off. After making all connections, turn the projector on first. The computer should always be turned on last.

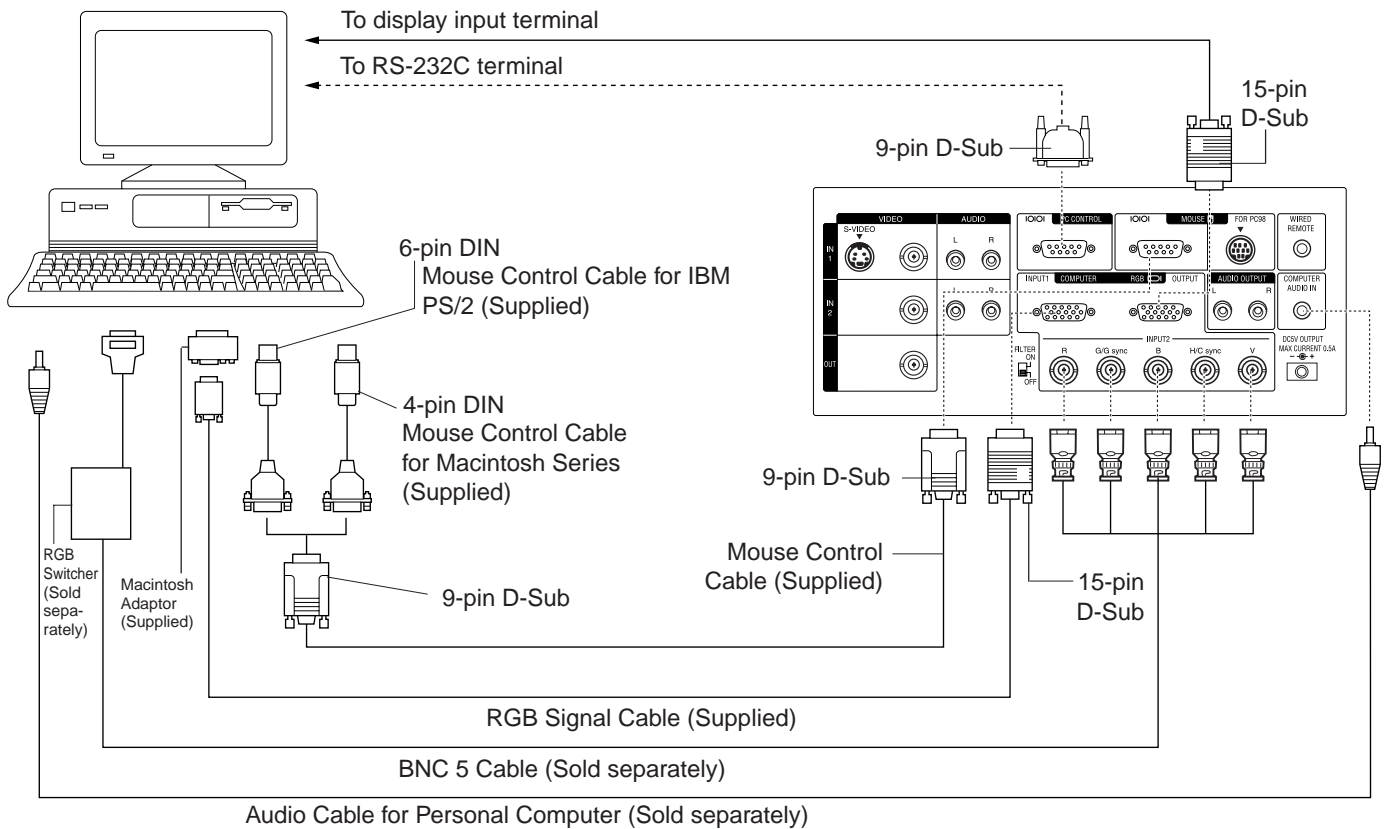

- You can connect your projector to a computer for easy projection of full color computer images and an external monitor for simultaneous viewing. See pages 17 and 18 for details of the connections.
- Refer to page 20 for a list of personal computers connectable to the projector. Use with computers other than those listed may cause some of the functions not to work.
- When the RS-232C terminal on this unit is connected to a personal computer via an RS-232C cable (cross type), the personal computer can control the projector and the status of the projector can be checked. See pages 34 and 35 for details.
- By connecting the projector mouse terminal to your personal computer's mouse terminal, using the supplied mouse control cables, you can use the remote control in place of the computer's mouse. Refer to page 8 for details.

**Notes:**

- The wireless mouse or RS-232C function may not operate if your computer port is not correctly set-up. Please refer to your computer owners manual for details on setting-up/installing the correct Mouse Driver.
- Do not connect or remove the mouse control cable or RS-232C cable to/from your computer while it is on. This may damage your computer.
- Do not connect to the mouse input terminal for IBM/Mac and mouse input terminal for PC98 simultaneously.

## “Plug And Play” Function

This projector is compatible with VESA DDC 1 and DDC 2B standards. This projector and a VESA DDC compatible computer will communicate their setting requirements, allowing for quick and easy set-up.

**Notes:**

- The “plug and play” function cannot be used with RGB 2 input.
- The DDC, “plug and play” function of this projector is only functional when used in conjunction with a VESA DDC compatible computer.

# Connecting to the Computer RGB Input (RGB 1)/Output (RGB 1, 2) Terminals

- You can connect your projector to a computer for easy projection of full-color computer images, and an external monitor for simultaneous viewing.
- Use the RGB 1 input connector and the supplied RGB cable for Plug & Play.

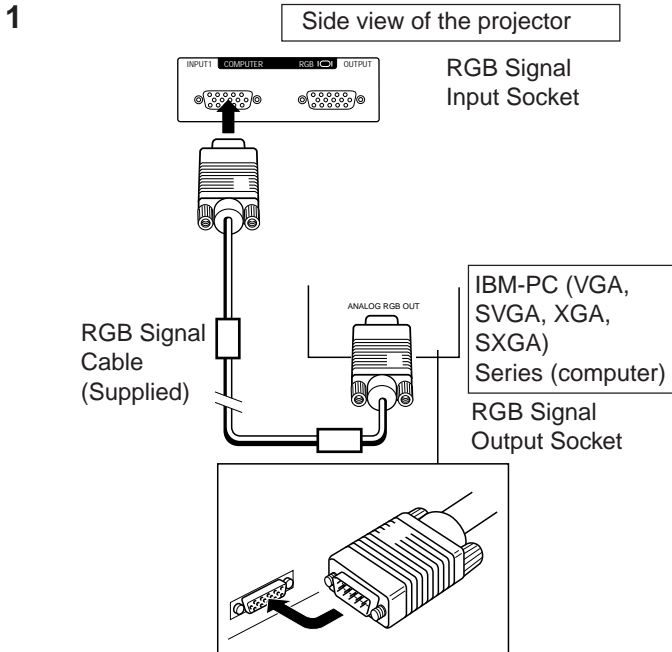

## 1. Connecting to an IBM-PC (VGA, SVGA, XGA, SXGA) Series computer – 1,280 × 1,024 maximum resolution

Plug the RGB signal cable correctly into the RGB INPUT terminal on the projector and into the RGB signal output terminal on the computer, and secure the plugs by tightening the thumb screws.

**Note:**

- This connection is possible only when using a computer with a VGA/ SVGA/XGA/SXGA or Mac display output port.

## 2 1 Macintosh Adaptor (Supplied)

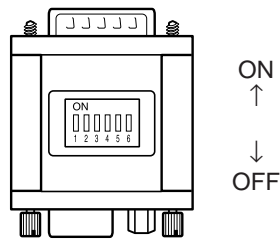

## 2. Connecting to a Macintosh Series Computer

- 640 × 480, 832 × 624 or 1,024 × 768 resolution

- 1 Set the proper switches on the supplied adaptor.
  - For 640 × 480 resolution, set switches 1 and 2 to “ON” and 3, 4, 5 and 6 to “OFF”.
  - For 832 × 624 resolution, set switches 2 and 4 to “ON” and 1, 3, 5 and 6 to “OFF”.
  - For 1,024 × 768 resolution, set switches 2 and 3 to “ON” and 1, 4, 5 and 6 to “OFF”.

## 2 2 Macintosh Adaptor (Supplied)

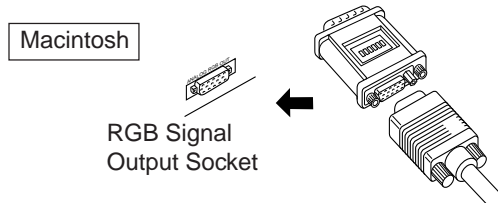

- 2 Connect the supplied Macintosh adaptor to the RGB signal output terminal on your Macintosh Series computer, as shown on the left, and secure the plugs by tightening the thumb screws.

## 2 3 Side view of the projector

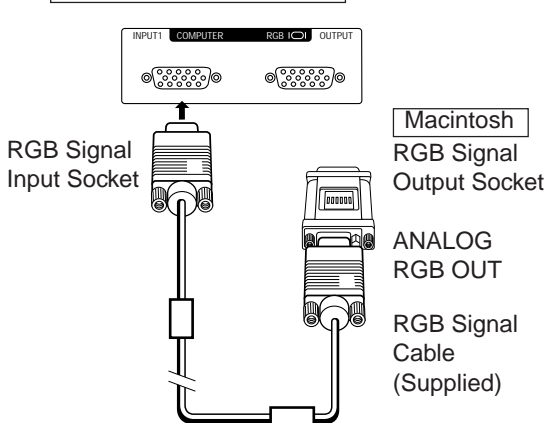

- 3 Firmly plug the supplied RGB signal cable into both the RGB input terminal on the projector and the Macintosh adaptor on the computer, and secure the plugs by tightening the thumb screws.

**Notes:**

- Be sure to use the supplied Macintosh adaptor.
- Be sure the switches on the adaptor are properly set.
- Once the adaptor is connected to a computer and the computer is turned on, the display mode cannot be changed even if the switches on the adaptor are reset.
- The supplied adaptor is only for use with H-SYNC and V-SYNC output. When connecting a Macintosh Series computer that only outputs C-SYNC, use a special C-SYNC output adaptor (sold separately).

### 3. Connecting to other compatible computers

When connecting the projector to a compatible computer other than an IBM-PC (VGA/SVGA/XGA/SXGA) or Macintosh series, a separate cable is needed. Please contact your dealer for ordering information.

**Notes:**

- Connecting computers other than the recommended types may result in damage to the projector, the computer, or both.
- Connect the audio from the computer to the COMPUTER AUDIO INPUT terminal.

### 4. Connecting to the COMPUTER AUDIO INPUT

- The COMPUTER AUDIO INPUT accepts COMPUTER RGB input.
- Connect a 3.5 mm Stereo Minijack-RCA L/R cable (not included) from the audio output terminal on the computer to the COMPUTER AUDIO IN terminal on the projector.

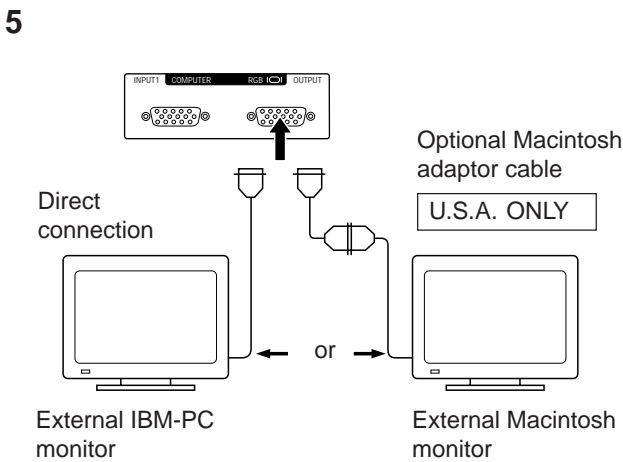
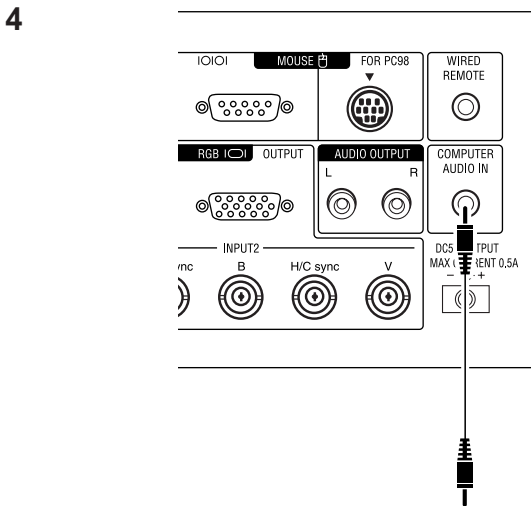

### 5. Connecting an external monitor

Connect your computer monitor to the projector's COMPUTER RGB OUTPUT terminal to view images simultaneously on the external monitor and the projection screen. Select either RGB 1 or RGB 2 to output the images to the monitor.

**Caution (Apple Macintosh):**

Do not connect the COMPUTER RGB OUTPUT to any monitor except the following:  
 Apple Color RGB Monitor 13"/14" (640 × 480),  
 16"/17" (832 × 624) or 19" (1,024 × 768)  
 The output signal from the projector to the monitor should be the same as the input signal from the computer to the projector.

**Example:** Input 13"/14" (640 × 480) → Output (640 × 480)  
 Input 16"/17" (832 × 624) → Output (832 × 624)  
 Input 19" (1,024 × 768) → Output (1,024 × 768)

**Note:**

- The supplied adaptor is only for use with H-SYNC and V-SYNC output. No picture will appear when connected to monitors that only use C-SYNC.

**Notes:**

- When using the projector with an external IBM-PC monitor, connect the monitor using the supplied cable. When using the projector with a Macintosh monitor, an optional adaptor cable is required. Before using any other type of monitor, carefully check the monitor's interface specifications and make sure that they match the specifications of the projector's interface.
- The external monitor output will only display an analog computer input signal. It will not display a digital or video input signal. To split the composite video signal, use a video distribution amplifier. This is available from your local dealer. The computer RGB output will only loop through the same signal connected to the computer RGB input. (VGA IN → VGA OUT, Mac IN → Mac OUT)



# Connecting the Projector (RGB 2)

## Connecting to the Computer RGB 2 Input Terminals

■ Prevents a deterioration of picture quality to enable 5 BNC computer input.

- Before connecting, be sure to turn both the projector and the equipment off.
- Connect the R, G/G-SYNC, B, H/C-SYNC and V-SYNC cables to the correct input terminals on the projector and an RGB switcher (sold separately) connected to the computer, or connect a 5 BNC-VGA cable (sold separately) directly from the input terminals on the projector to the computer.

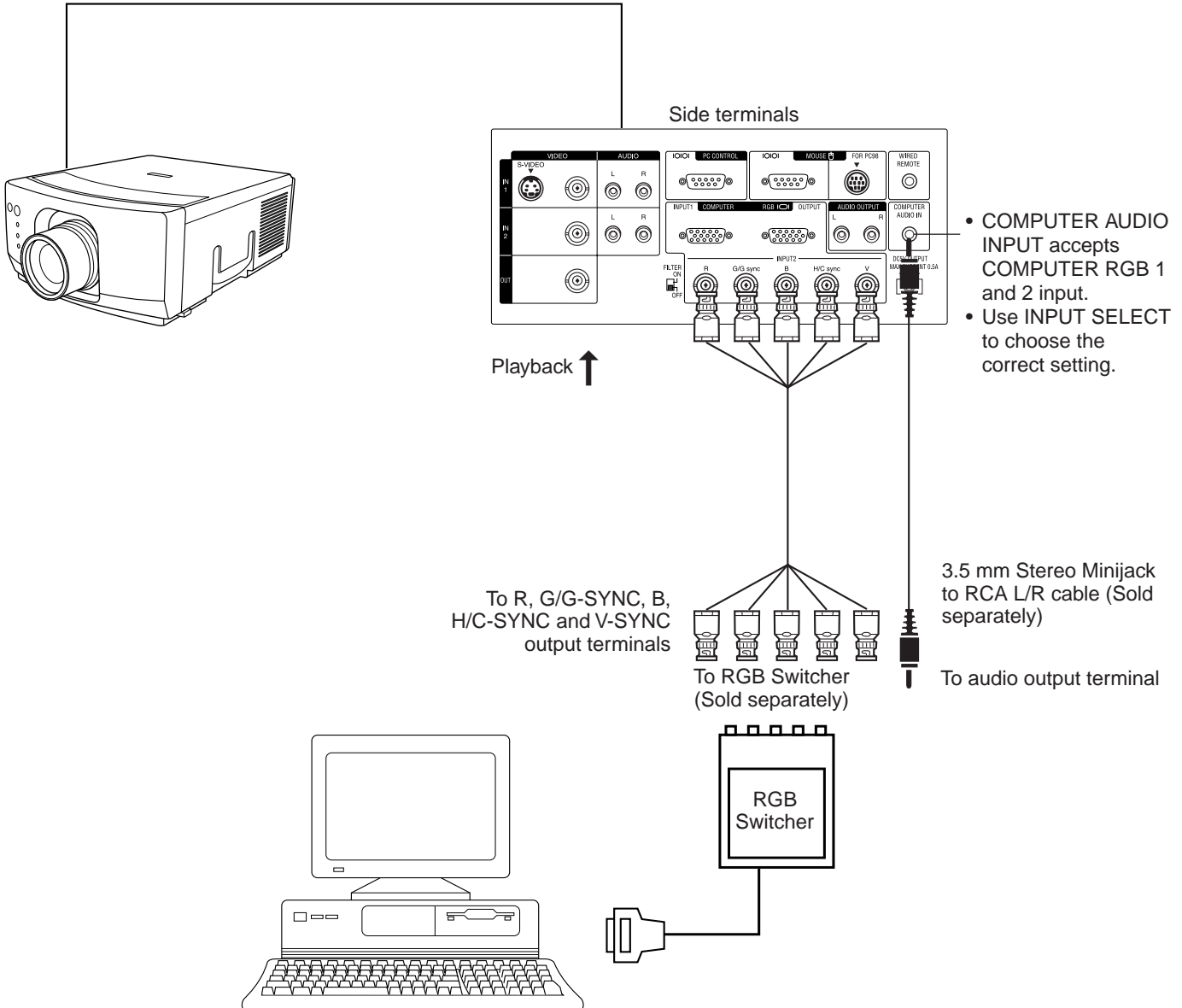

### Note:

- When connecting a Macintosh Series computer that outputs C-SYNC, connect the cable to the COMPUTER RGB 2 INPUT H-SYNC input terminal.

# Input Signals (Recommended Timing)

## For IBM and compatibles

Input signals: The video output signal timing of different types of video signals are shown below for reference.

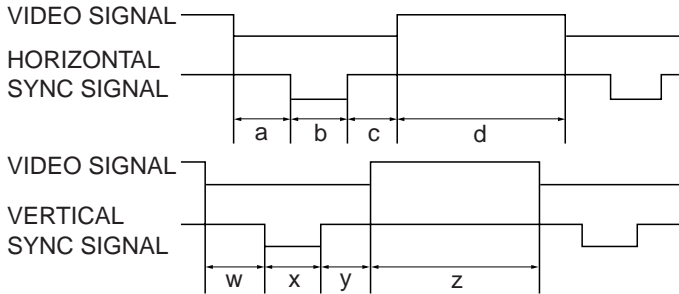

## For Apple Macintosh Series

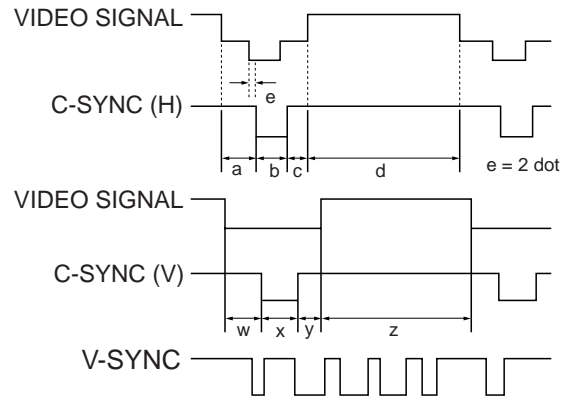

MODE		IBM										Apple		Apple		Apple		Apple				
		VGA										Macintosh™ IIsi	Macintosh™ LC	Macintosh™	Macintosh™							
		Text		Graphic				Graphic	Graphic	VESA Guideline	VESA Standard	VESA Standard	VESA Guideline	VESA Standard	VESA Standard	13" Monitor	13" Monitor	16" Monitor	19" Monitor			
		720 dots	640 dots	640 dots	800 dots	800 dots	800 dots	800 dots	800 dots	1,024 dots	1,024 dots	1,024 dots	1,280 dots	1,280 dots	640 dots	640 dots	832 dots	1,024 dots				
VIDEO		LEVEL		TYPE		TYPE		TYPE		TYPE		TYPE		TYPE		TYPE		TYPE				
		0.7Vp-p 75Ω load		R • G • B		R • G • B		R • G • B		R • G • B		R • G • B		R • G • B		R • G • B		R • G • B				
H S Y N C	FRONT PORCH	a	dot	17		14		24	24	40	56	16	24	24	16	48	16	64	78	31	35	
	SYNC	b	dot	108		96		40	72	128	120	80	136	136	96	112	144	64	62	65	96	
	BACK PORCH	c	dot	55		50		128	128	88	64	160	160	144	176	248	248	96	116	224	173	
	VIDEO PERIOD	d	dot	720		640		640	800	800	800	800	1,024	1,024	1,024	1,280	1,280	640	640	832	1,024	
	1H (a+b+c+d)	dot		900		800		832	1,024	1,056	1,040	1,056	1,344	1,328	1,312	1,688	1,688	864	896	1,152	1,328	
		μs		31.7774		31.7776		26.413	28.444	26.400	20.800	21.333	20.677	17.707	16.660	15.6	12.5	28.5714	28.595	20.124	16.650	
	1 dot		ns	35.3082		39.7219		31.746	27.777	25.000	20.000	20.202	15.385	13.3	12.7	9.3	7.4	33.0688	31.914063	17.468	12.538	
	1/H		kHz	31.4689		31.4688		37.860	35.156	37.879	48.077	46.875	48.363	56.476	60.023	63.981	79.976	35.0000	34.971149	49.693	60.0	
	1/dot		MHz	28.322		25.175		31.500	36.000	40.000	50.000	49.500	65.000	75.0	78.75	108.000	135.000	30.2400	31.334149	57.246	79.76	
	LEVEL			TTL	TTL	TTL		TTL	TTL	TTL	TTL	TTL	TTL	TTL	TTL	TTL	TTL	TTL	TTL	TTL	TTL	TTL
SYNC POLARITY		+/-	+	-	+	-	-	+/-	+	+	+	-	-	+	+	+	-	-	-	-		
V S Y N C	FRONT PORCH	w	H	38	13	38	13	11	9	1	1	37	1	3	3	1	1	1	3	3	1	3
	SYNC	x	H	2	2	2	2	2	3	2	4	6	3	6	6	3	3	3	3	3	3	3
	BACK PORCH	y	H	59	34	59	34	32	28	22	23	23	21	29	29	28	38	38	39	39	39	30
	VIDEO PERIOD	z	H	350	400	350	400	480	480	600	600	600	600	768	768	768	1,024	1,024	480	480	624	768
	1V (w+x+y+z)	H		449	449	449	449	525	520	625	628	666	625	806	806	800	1,066	1,066	525	525	667	804
		ms		14.2681	14.2681	14.2681	14.2681	16.6832	13.735	17.778	16.579	13.853	13.333	16.666	14.272	13.328	16.7	16.7	15.00	15.00	13.423	13.387
	1/v		Hz	70.0866	70.0866	70.0863	70.0863	59.9405	72.809	56.250	60.317	72.188	75.000	60.006	70.069	75.029	60.020	75.025	66.67	66.67	74.502	74.70
	LEVEL			TTL	TTL	TTL	TTL	TTL	TTL	TTL	TTL	TTL	TTL	TTL	TTL	TTL	TTL	TTL	TTL	TTL	TTL	TTL
SYNC POLARITY		+/-	-	+	-	+	-	+/-	+	+	+	-	-	+	+	+	-	-	-	-		

### Notes:

- When connecting a notebook computer to the data-projector for display on an (800 × 600) LCD screen, the screen may not show a full picture image. See page 22, "Computer Mode Memory Adjustments" for details.
- This projector may not be able to display images from notebook computers in simultaneous (CRT/LCD) mode. If this occurs, turn off the LCD display on the notebook computer and output the display data in "CRT only" mode. Details on how to change display modes can be found in your notebook computer's operation manual.

# RGB Adjustment Controls

- When displaying computer patterns which repeat every other dot (tiling, vertical stripes, etc.), interference may occur between the LCD pixels, causing flickering, vertical stripes, or contrast irregularities in portions of the screen. Should this occur, use the ADJUSTMENT ◀/▶ buttons for HORIZONTAL (LEFT/RIGHT) and VERTICAL (UP/DOWN) position adjustments to adjust for the optimum picture.

## RGB Input Adjustments (CLOCK, PHASE, V-POS and H-POS)

1. Select RGB 1 or 2 with the INPUT SELECT button and press the MENU button to select the RGB INPUT ADJ. mode.

With the MENU screen displayed, press the ADJUSTMENT ▼/▲ buttons to select "RGB1 INPUT ADJ." Then press the ENTER button to display the RGB1 INPUT ADJ. screen.

2

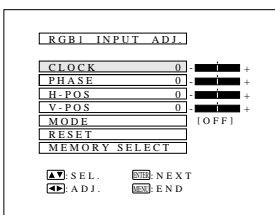

2. Select the item you wish to adjust with the ADJUSTMENT ▼/▲ buttons. Adjust the item with the ADJUSTMENT ◀/▶ buttons.

### Note:

- To display only the item that you want to adjust, press the ENTER button after selecting the item with the ADJUSTMENT ▼/▲ buttons. Then adjust the item with the ADJUSTMENT ◀/▶ buttons.

3. Press the MENU button anytime to exit RGB INPUT ADJ.

## Description of Adjustment Items

### CLOCK SPEED ADJUSTMENT (FAST/SLOW)

- Adjust the input signal horizontal frequency and the dot clock so that the screen display is normal.

### PHASE ADJUSTMENT (UP/DOWN)

- Used to reduce image distortion or improve contrast.

### HORIZONTAL POSITION ADJUSTMENT (LEFT/RIGHT)

- Used to center the on-screen image by moving it to the left or right.

### VERTICAL POSITION ADJUSTMENT (UP/DOWN)

- Used to center the on-screen image by moving it up or down.

### MODE ADJUSTMENT

#### Connecting to IBM-PC Computers

- Ordinarily, the type of input signal is detected and the correct resolution mode (Text or Graphics) is automatically selected. However, for the following signals, set MODE to ON or OFF to select the projector's resolution mode to match the computer display mode properly.
  - 720 dots × 400 lines, 720 dots × 350 lines (Text Mode)
  - 640 dots × 400 lines, 640 dots × 350 lines (Graphic Mode)
- For graphic mode, select MODE and set the MODE to ON.
- For text mode, select MODE again at this time, and set MODE to OFF.

#### Connecting to Macintosh LC/II Series Computers

- When connecting to a Macintosh II with 35 kHz Dot Frequency, select MODE and set MODE to ON.
- When connecting to a Macintosh LC Series computer with 34.97 kHz Dot Frequency, set MODE to OFF.
- When connecting to third party video cards and other Macintosh computers, set MODE to ON or OFF to select the correct display mode.
- When the input signal is automatically detected or when there is no input signal, MODE (---) appears on the screen and the display mode cannot be changed.

### INITIAL RESET

- To return the H-POS, V-POS, PHASE and CLOCK adjustments to their initial settings, select RESET and then press the ENTER button.

### MEMORY SELECT

- Used to store up to seven computer mode adjustments.

### INPUT ADJUSTMENT

#### ① Filter switch

In the case of very detailed computer patterns which repeat every other dot (tiling, vertical stripes, etc.), noise may appear on the screen. Should this occur, set the FILTER switch to ON. The pattern area will balance, and the noise will be reduced.

### Note:

- Avoid displaying computer patterns which repeat every other line (horizontal stripes). (Flickering may occur, making the picture hard to see.)

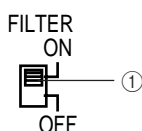

## Computer Mode Memory Adjustments

- The projector has been preset with different modes for use with SVGA and other compatible computers. However, 7 memory positions are provided to store mode adjustments.
- Each memory position can be used to store mode adjustments to match the computer.

1 When RGB 1 or 2 is selected.

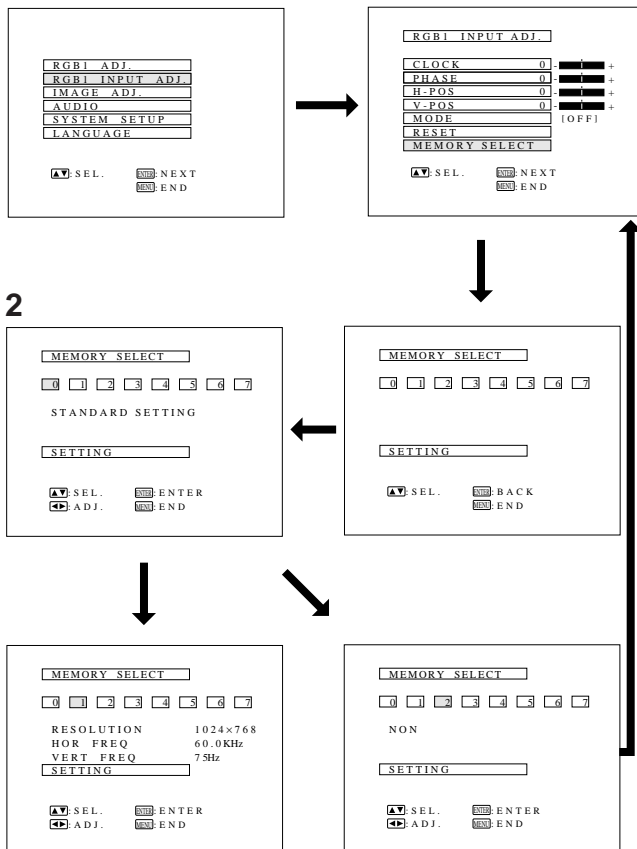

1. Press the ENTER button to select the Memory Adjustment mode.

- Press the MENU button. While the MENU screen is displayed, press the ADJUSTMENT ▼/▲ buttons to select “RGB1 INPUT ADJ.” Press the ENTER button. The MENU mode changes as shown.
- While the RGB INPUT adjustment menu is displayed, press the ADJUSTMENT ▼/▲ buttons to select “MEMORY SELECT”. Then press the ENTER button to change the image.

2. Press the ADJUSTMENT ◀/▶ buttons.

- The screen shown on the left will appear. There are 7 memory positions.
- Press the ADJUSTMENT ▼ button once to move to the following screen. Press the ADJUSTMENT ◀/▶ buttons to select the number of the memory you want to adjust. If that memory position has not been set, the screen on the right will be displayed. If it has been set, the screen on the left will be displayed. MEMORY No.0 cannot be set. It contains the fixed factory preset settings.
- To make or change a setting, press the ADJUSTMENT ▼/▲ buttons to move the cursor to “SETTING.” Then press the ENTER button to go to the RGB INPUT adjustment menu screen. (If you do not want to make any adjustments, press the MENU button.)
- Select the item you want to adjust by pressing the ADJUSTMENT ▼/▲ buttons, then use the ADJUSTMENT ◀/▶ buttons to make the adjustments. When adjustments are completed, press the MENU button. The display disappears and the adjustments are stored in memory as a user mode. See page 21 for details on the adjustment items.

3. Press the MENU button anytime to exit RGB INPUT ADJ.

# Basic Operation of the Projector

1

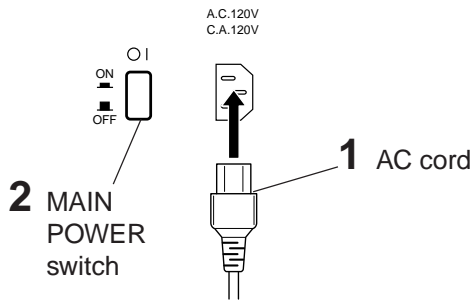

## 1. Connect the AC cord.

Connect the supplied AC cord to the AC inlet on the side of the projector .

2

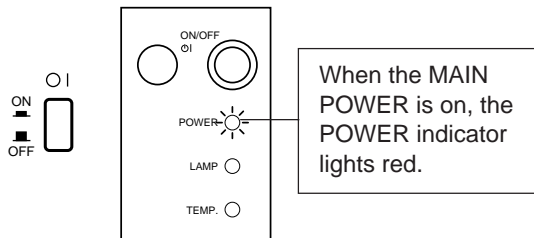

## 2. Turn on the MAIN POWER.

Press the MAIN POWER switch on the side of the projector. The POWER indicator lights red and the projector enters STANDBY mode.

3

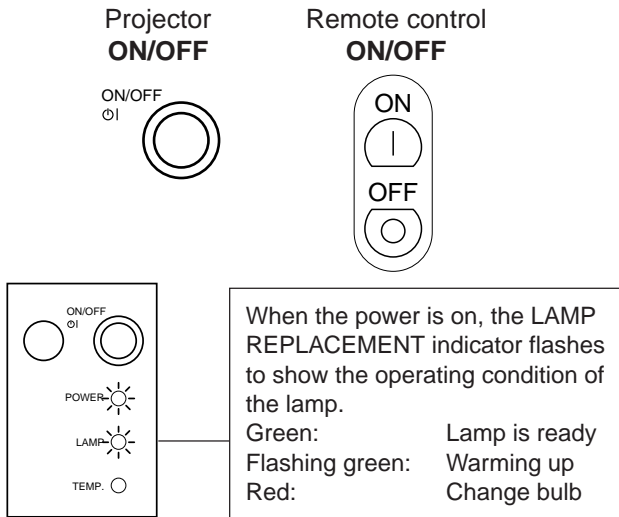

## 3. Turn on the POWER.

Press the POWER ON/OFF button on the projector or the POWER ON button on the remote control.

- When the power is turned off by pressing the POWER ON/OFF button, the POWER indicator will not turn off until the fan has stopped running.
- See page 32, "Lamp/Maintenance Indicators" for details.

### Notes:

- When the POWER indicator is not lit, the remote control cannot be used to operate the projector.
- If the power is turned on immediately after it has been turned off, it may take a short while before the lamp turns on. (During this period the LAMP REPLACEMENT indicator flashes.)
- After the projector is unpacked and turned on for the first time, a slight odor may be emitted from the exhaust fan. This odor will soon disappear with use.

### Caution:

- Be sure to take off the lens cap before operation of the projector. Do not place the lens cap on the lens during operation. The lens cap may become extremely hot.



4

On-Screen Display

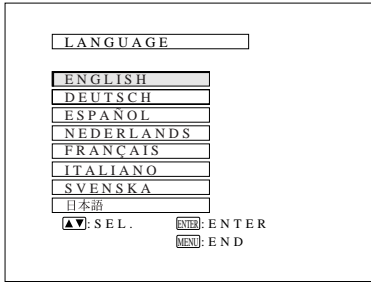

4. Select one of eight ON-SCREEN DISPLAY languages.

You can return to the previous screen by selecting the uppermost item (turquoise) with the ADJUSTMENT ▼/▲ buttons (in this case, LANGUAGE) and then pressing the ENTER button.

The on-screen display is set to English at the factory. The language for the unit's ON-SCREEN DISPLAY can be set to English, German, Spanish, Dutch, French, Italian, Swedish or Japanese.

Setting the ON-SCREEN DISPLAY language

- 1) Press the MENU button. The menu will appear on the screen.
- 2) Press the ADJUSTMENT ▼/▲ buttons to highlight the LANGUAGE item yellow. Then press the ENTER button to display the language menu.
- 3) Press the ADJUSTMENT ▼/▲ buttons to highlight the desired language yellow. Then press the ENTER button to set the language. The ON-SCREEN DISPLAY is now programmed to display in the language chosen.

5

On-Screen Display

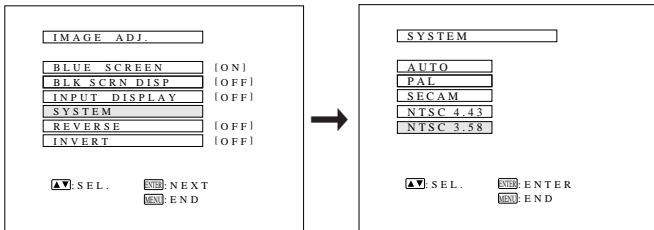

5. Change the system mode.

The video input system mode is set to AUTO at the factory, but it can be changed to a different mode if the selected system mode is not compatible with the connected audiovisual equipment (when a color image appears in black and white, etc.).

- 1) Press the MENU button. The menu will appear on the screen.
- 2) Press the ADJUSTMENT ▼/▲ buttons to highlight the "IMAGE ADJ." yellow. Then press the ENTER button to display the IMAGE ADJ.
- 3) Press the ADJUSTMENT ▼/▲ buttons to highlight SYSTEM yellow. Then press the ENTER button to display the SYSTEM.
- 4) Press the ADJUSTMENT ▼/▲ buttons to highlight yellow the video system desired yellow. Then press the ENTER button to set the system.

Notes:

- In AUTO mode, "PAL," "SECAM," "NTSC 4.43" or "NTSC 3.58" is displayed on the screen for a few seconds when the mode is changed with the INPUT SELECT button.
- When the system mode is set to AUTO, you may not receive a clear picture due to signal differences. If this happens, switch to the color system you are viewing.

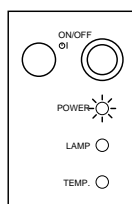
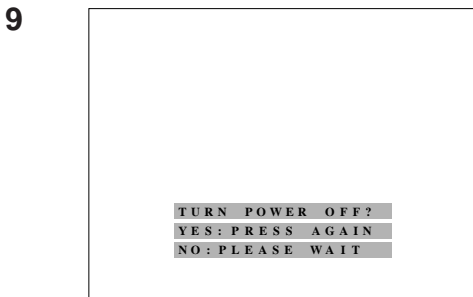
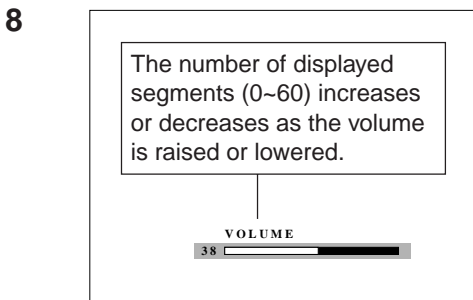
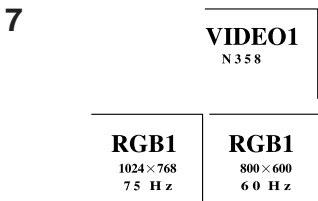
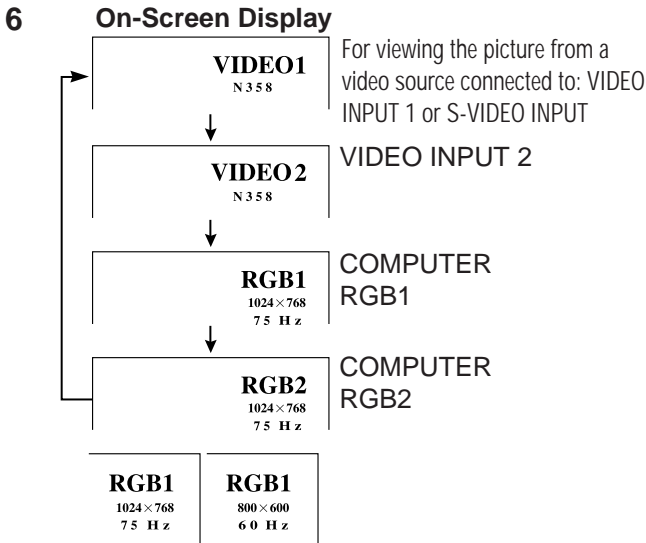

## 6. Select input.

Press the INPUT SELECT button on the projector to switch the picture input. When you press the button, the current input mode is displayed for about 4 seconds. If you press the button again while the input mode is displayed, the mode changes as shown on the left.

Confirm the selected input terminal and press the INPUT SELECT button.

### Notes:

- This can be selected directly using the VIDEO 1, VIDEO 2, DATA 1 and DATA 2 buttons on the remote control.
- In VIDEO mode, the system being received will be indicated below the "VIDEO" display.
- When selecting RGB mode, the resolution being displayed will be indicated under "RGB," as shown on the left. (Refer to the second example when connecting to Mac display.)
- When no signals are being received, "NO SIGNAL" will be displayed. When receiving a signal the projector is not preset to receive, "NOT REG." will be displayed. (This display function does not operate in Video mode.)
- The picture size differs in RGB, NTSC, PAL and SECAM INPUT modes.

## 7. Press INPUT CHECK.

When the INPUT CHECK button on the remote control is pressed, the current input mode is displayed for about 4 seconds.

### Note:

- The INPUT CHECK button will not function if the INPUT DISPLAY is turned off, as described on page 30.

## 8. Adjust the volume.

Press the VOLUME UP-DOWN buttons on the projector or on the remote control to adjust the volume.

### MUTE

- Press the MUTE button to temporarily turn off the sound.
- Press the MUTE button once again to turn the sound back on.

## 9. To turn off the power from the projector or remote control

- Press the POWER ON/OFF button on either the projector or the remote control. The screen on the left will appear.
- If you want to turn off the power, press the POWER ON/OFF button on either the projector or the remote control again within 4 seconds. The power is now temporarily turned off.
- If you accidentally pressed the POWER ON/OFF button and do not want to turn off the power, wait until the On-Screen Display disappears before turning the power on again.

The POWER indicator will turn red and the cooling fan will run for 90 seconds, then the power will turn off, and the projector will return to STANDBY mode.

The power can be turned on again either from the projector or remote control. When the power is turned on, the POWER indicator and LAMP REPLACEMENT indicator light green.

### Note:

- When the MAIN POWER is off on the projector set, the power cannot be turned on from the remote control.

# Adjusting the Picture

- This projector's picture is factory preset to standard settings. However, you can adjust it to suit your own preferences with the ADJUSTMENT buttons on the projector and the remote control.
- The adjustments can be memorized in RGB 1, RGB 2 or VIDEO separately.
- Four picture modes can be adjusted: "PICTURE," "BRIGHT," "RED," and "BLUE."

## 1 On-Screen Display

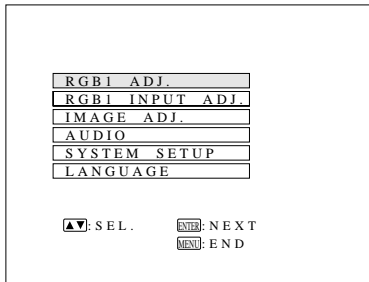

## 2

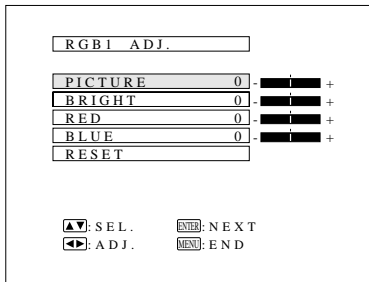

## 3

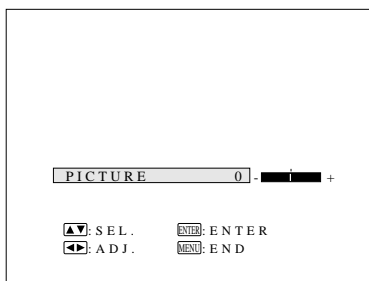

## Adjusting the Picture

### 1. Use the MENU button to select the mode to be adjusted.

- When the MENU button is pressed, the MENU mode is indicated for about 30 seconds. Press the ADJUSTMENT ▼/▲ buttons to select RGB1 ADJ., then press the ENTER button.

### 2. Adjust the Picture

- Press the ADJUSTMENT ▼/▲ buttons to highlight yellow the picture adjustment item you want to adjust.
- Press the ADJUSTMENT ◀/▶ buttons to move the "0" mark of the selected adjustment item to the desired setting.
- The adjustment mode is displayed for about 30 seconds.

### Description of Adjustment Items

Selected item	ADJUSTMENT ◀ button	ADJUSTMENT ▶ button
PICTURE	For less contrast	For more contrast
BRIGHT	For less brightness	For more brightness
RED	For weaker red	For stronger red
BLUE	For weaker blue	For stronger blue
COLOR	For less color intensity	For more color intensity
TINT	Skin tones become purplish	Skin tones become greenish
SHARPNESS	For less sharpness	For more sharpness
RESET	All RGB Video Adjustment items are returned to the factory preset settings. <b>Note:</b> To reset all adjustment items, select RESET in "RGB1 ADJ." mode and press the ENTER button.	

### 3. Display only the item to adjust.

- Press the ADJUSTMENT ▼/▲ buttons to highlight yellow the picture adjustment item you want to adjust. If you press the ENTER button at this time, only the selected item will be displayed.
- Press the ADJUSTMENT ◀/▶ buttons to move the "0" mark of the selected adjustment item to the desired setting.
- The adjustment mode is displayed for about 30 seconds.

#### Notes:

- When a VIDEO signal input has been selected, only "PICTURE," "BRIGHT," "COLOR," "TINT" and "SHARPNESS" can be adjusted.
- TINT only appears in NTSC mode.

### 4. Press the MENU button anytime to exit RGB ADJ.

# Adjusting the Audio

- The projector's audio is factory preset to the standard setting. However, you can adjust it to suit your own preference with the ADJUSTMENT buttons on the projector or the remote control.
- You can adjust the BALANCE, TREBLE and BASS.

- To return to the factory preset mode, press the ADJUSTMENT ▼/▲ buttons to select "RESET", then press the ENTER button.
- Press the MENU button to select the normal screen mode.

## On-Screen Display

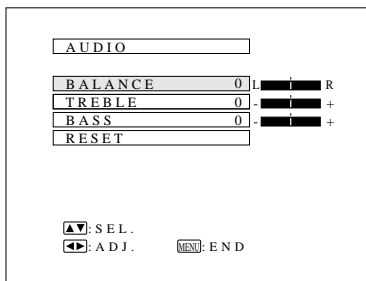

## Adjusting the Audio

- Press the MENU button. Select "AUDIO" with the ADJUSTMENT ▼/▲ buttons. Then press the ENTER button to change to the picture indicated on the left.
- Select "BALANCE," "TREBLE" or "BASS" with the ADJUSTMENT ▼/▲ buttons. Adjust the mode you want with the ADJUSTMENT ◀/▶ buttons.
- To return to the factory preset mode, press the ADJUSTMENT ▼/▲ buttons to select RESET, then press the ENTER button.

### Description of Adjustment Items

Selected items	ADJUSTMENT ◀ button	ADJUSTMENT ▶ button
BALANCE	Increased audio from the left speaker	Increased audio from the right speaker
TREBLE	Weaker treble	Stronger treble
BASS	Weaker bass	Stronger bass

# Functions on the Projector

## On-Screen Display

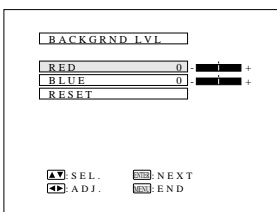
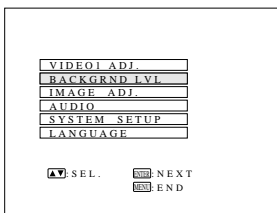
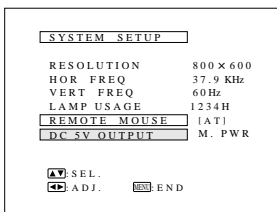
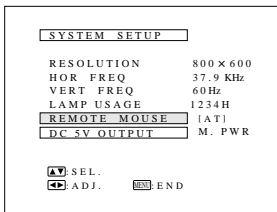
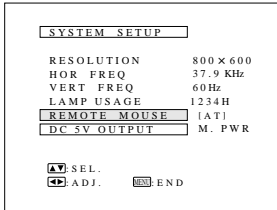

## Setting Up the System

- Using this function, you can check the input signal and lamp usage time, and select the remote mouse and DC 5V output.

## Checking the system and lamp usage time

- Press the MENU button. Select "SYSTEM SETUP" with the ADJUSTMENT ▼/▲ buttons. Then press the ENTER button to change to the picture indicated on the left.
- The current system conditions, including the lamp usage time, will be displayed on the screen.
- Press the MENU button to select the normal screen mode.

### Note:

- In the video screen, the resolution and frequency settings will not be displayed.

## Selecting the Remote Mouse

- Press the MENU button.
- Select SYSTEM SETUP with the ADJUSTMENT ▼/▲ buttons. Then press the ENTER button.
- Select "REMOTE MOUSE" and then select either "[AT]" or "[98]" with the ADJUSTMENT ◀/▶ buttons.
- Select [AT] when using IBM compatibles and Apple Macintosh series.
- Select [98] when using NEC PC98 series (for Japan).
- Press the MENU button to select the normal screen mode.

## Selecting DC 5V output

- Press the MENU button.
- Select "SYSTEM SETUP" with the ADJUSTMENT ▼/▲ buttons. Then press the ENTER button.
- Select "DC 5V OUTPUT" and then select either "M.PWR" or "LAMP" with the ADJUSTMENT ◀/▶ buttons.
- Select "M.PWR" when you want a continuous current supply from the DC 5V OUTPUT with the main power on.
- Select "LAMP" when you want a current supply from the DC 5V OUTPUT only when LAMP is set to "ON".
- Press the MENU button to select the normal screen mode.

## Background level

- The Background Level adjustment can be used to adjust the picture white balance for the selected Video Input Source.
- Optimal image quality can be achieved by adjusting the white portion of the picture to obtain the best color for the selected source.

## Adjusting the BACKGROUND LEVEL

- Press the MENU button. Select "BACKGRND LVL" with the ▼/▲ buttons. Then press the ENTER button to change the picture as indicated on the left.
- Select "RED" or "BLUE" with the ▼/▲ buttons. Adjust the mode you want with the ◀/▶ buttons.
- To return to the factory preset mode, press the ▼/▲ buttons to select "RESET" then press the ENTER button.
- Press the MENU button to select the normal screen mode.

### Note:

- To display only the item that you want to adjust, press the ENTER button after selecting the item with the ADJUSTMENT ▼/▲ buttons. Then adjust the item with the ADJUSTMENT ◀/▶ buttons.

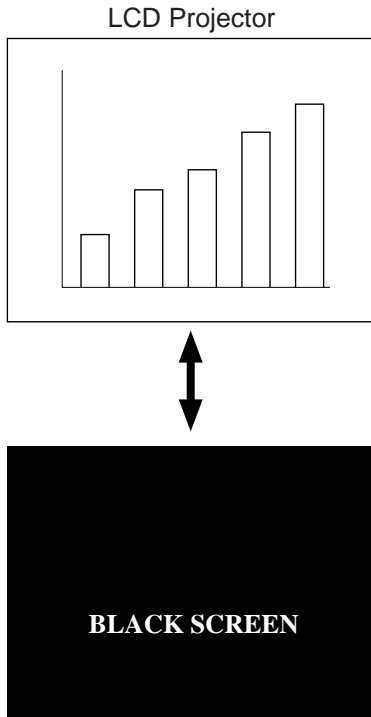

## Using the Black Screen Function

■ This projector is equipped with a Black Screen Function. This function can be used to black out the presentation image.

- Press the BLACK SCREEN button on the projector or the remote control to display the black screen. Press the BLACK SCREEN button again to return to the presentation image.

**Note:**

- When BLK SCR N DISP is set to OFF, the On-Screen Display (“BLACK SCREEN”) will not appear during black screen. See below.

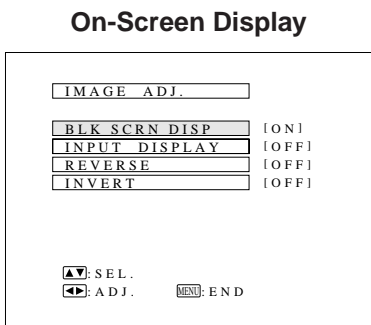

## Black Screen On-Screen Display override

■ The On-Screen Display (“BLACK SCREEN”) that appears during black screen can be turned off. When BLK SCR N DISP is set to OFF, the On-Screen Display will not appear during black screen.

- Press the MENU button. While the MENU screen is displayed, press the ADJUSTMENT ▼/▲ buttons to select “IMAGE ADJ.” Then press the ENTER button to display the IMAGE ADJ. screen as shown. Press the ADJUSTMENT ▼/▲ buttons to select “BLK SCR N DISP” and press the ADJUSTMENT ◀/▶ buttons to select ON or OFF.

### On-Screen Display

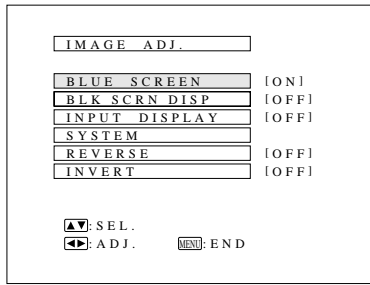

### On-Screen Display



### On-Screen Display

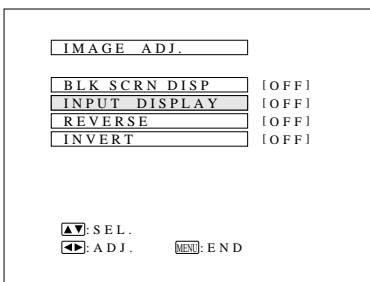

## Using the Blue Screen Function

- This projector is equipped with a Blue Screen function that will turn the screen blue when the video input terminal is not connected to anything, or the video component is turned off.
- Press the MENU button. While the MENU screen is displayed, press the ADJUSTMENT  $\blacktriangledown/\blacktriangle$  buttons to select "IMAGE ADJ." Then press the ENTER button to display the IMAGE ADJ. screen as shown. Press the ADJUSTMENT  $\blacktriangledown/\blacktriangle$  buttons to select "BLUE SCREEN," and press the ADJUSTMENT  $\blacktriangleleft/\blacktriangleright$  buttons to select ON or OFF. Press the MENU button to return to the normal screen.
- When the Blue Screen function is on, the screen will turn blue when no video signal is being input through the video input terminal.
- When the Blue Screen function is on, and no video signal is input via the input terminal for more than 15 minutes, the power is automatically turned off.
- The indicators appear as shown each minute before the power is turned off, from five minutes before until one minute before.

#### Notes:

- The Blue Screen Function does not operate in RGB mode.
- When the power is turned off, the POWER indicator will light red.
- To turn the power on again, press the POWER button to set it to OFF, then press it again to set it to ON.

## Using the Input Mode On-Screen Display Override Function

The On-Screen Displays that appear during input select ("RGB 1,024 × 768, 75 Hz," etc.) can be turned off. Once INPUT DISPLAY is turned off, the On-Screen Displays will not appear even if the INPUT CHECK button on the remote control is pressed.

- Press the MENU button. While the MENU screen is displayed, press the ADJUSTMENT  $\blacktriangledown/\blacktriangle$  buttons to select "IMAGE ADJ." Then press the ENTER button to display the IMAGE ADJ. screen as shown. Press the ADJUSTMENT  $\blacktriangledown/\blacktriangle$  buttons to select "INPUT DISPLAY," and press ADJUSTMENT  $\blacktriangleleft/\blacktriangleright$  buttons to select ON or OFF.
- When OFF is selected, the On-Screen Display ("RGB 1,024 × 768, 75 Hz," etc.) will not be displayed during input select.



# Air Filter Maintenance

## 1. Bottom Air Filter

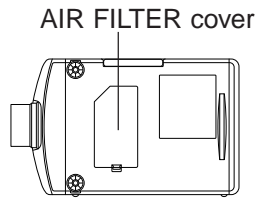

- The air filter should be cleaned every 100 hours of use. Clean the filter more often when the projector is used in a dusty or smoky location.
- Have your nearest Authorized Sharp Industrial LCD Products Dealer or Service Center exchange the filter (PFILD0082CEZZ) when it is no longer possible to clean it.

## Cleaning and Replacing the Filter

<p><b>1 Turn OFF the MAIN POWER.</b></p> <p>Turn off the MAIN POWER switch. POWER indicator goes off. Unplug the power cord.</p>	<p><b>2 Remove the FILTER COVER.</b></p> <p>Press the tab in the direction of the arrow and lift open the filter cover.</p>	<p><b>3 Remove the AIR FILTER.</b></p> <p>Grasp the air filter between your fingers and lift it out of the filter cover.</p>
<p><b>4 Clean the AIR FILTER.</b></p> <p>Clean the dust off the air filter and cover with a vacuum cleaner extension hose.</p>	<p><b>5 Replace the AIR FILTER.</b></p> <p>Place the filter underneath the tabs on the filter frame. Return the air filter to its original position in the filter cover opening.</p>	<p><b>6 Replace the FILTER COVER.</b></p> <p>Insert the tab on the end of the filter cover into the filter cover opening and press the filter cover into position.</p>

**Note:**

- Be sure the AIR FILTER COVER is securely installed. The power cannot be turned on unless it is correctly installed.

## 2. Side Air Filter

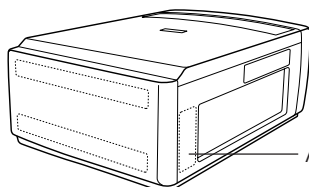

- The side air filter cannot be removed.
- If dust or dirt has collected inside the filter, clean the filter with a vacuum cleaner extension hose.

# Lamp/Maintenance Indicators

## Lamp

- The Lamp has a finite operating life of 1,500 hours. The lamp life may differ, however, depending on the usage environment.
- When the lamp is nearing the end of its operating life, the picture and color quality will deteriorate. When the projector is turned on after the lamp has been in use for more than 1,400 hours, the LAMP REPLACEMENT indicator will light red and "LAMP" will flash in yellow on the screen to alert you that it is time to replace the lamp. At this point, take your projector to the nearest Authorized Sharp Industrial LCD Products Dealer or Service Center to have the lamp replaced.

**Note:** The lamp usage time can be checked with the On-Screen display. (See page 28.)

**Caution:** Once you are alerted that the lamp requires replacement, take your projector to the nearest Authorized Sharp Industrial LCD Products Dealer or Service Center to have the lamp replaced.

- When the number of hours the lamp has been used reaches 1,500, the power automatically turns off and the projector enters the standby condition. If you turn on the power after the lamp has been used for 1,500 hours, "LAMP" will flash on screen in red letters for five minutes and then the power will turn off.
- Intense light hazard. Do not attempt to look into the aperture and lens while the projector is operating.

## Maintenance Indicators

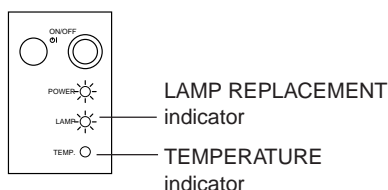

- The warning lights on the projector indicate problems inside the projector.
- There are two warning lights—a TEMPERATURE indicator which warns that the projector is too hot, and a LAMP REPLACEMENT indicator which lets you know when to change the lamp.
- If a problem occurs, either the TEMPERATURE indicator or the LAMP REPLACEMENT indicator will light up red, and the power will shut off. After turning off the power, follow the procedures given below.

Warning Indicator	Symptom	Problem	Possible Solution
TEMPERATURE indicator	The internal temperature is abnormally high.	• Blocked air intake.	• Relocate projector to a proper location.
		• Clogged air filter.	• Clean the filter. (See page 31.)
		• Cooling fan breakdown. • Clogged air filter. • Internal circuit failure.	• Take the projector to your nearest Authorized Sharp Industrial LCD Products Dealer or Service Center for repair.
LAMP REPLACE- MENT indicator	The lamp does not light up.	• Burnt-out lamp. • Lamp circuit failure.	• Take the projector to your nearest Authorized Sharp Industrial LCD Products Dealer or Service Center for repair.
	The lamp requires replacement.	• The lamp has been used for over 1,400 hours.	

### Notes:

- If the TEMPERATURE indicator comes on, follow the above possible solutions and then wait until the projector has cooled down completely before turning the power back on. (At least 5 minutes.)
- When the power is turned off and then turned on again, as during a brief rest, the LAMP replacement indicator may be triggered, preventing the power from going on. When this happens, take the power plug out of the AC outlet and put it back in again.

## Before Calling for Service

Problem	Check
No picture and no sound.	<ul style="list-style-type: none"> <li>• The projector AC cord is not plugged into the AC wall outlet.</li> <li>• The main power switch is not pressed.</li> <li>• The input is wrong. (See pages 24 and 25.)</li> <li>• Cables improperly connected to side panel of the projector. (See pages 15, 16, 17, 18 and 19.)</li> <li>• Remote control batteries have run down. (See page 7.)</li> <li>• The optional cable for the remote control is improperly inserted.</li> <li>• The main power of the remote control is not turned on.</li> <li>• The remote control's MOUSE/ADJUSTMENT switch is set to MOUSE.</li> <li>• The lamp has reached the end of its operating life. (See page 32.)</li> </ul>
Sound is heard but no picture appears.	<ul style="list-style-type: none"> <li>• Cables improperly connected to side panel of the projector. (See pages 15, 16, 17, 18 and 19.)</li> <li>• The BRIGHTNESS and PICTURE adjustments are set to minimum position. (See page 26.)</li> <li>• On-Screen Display ("BLACK SCREEN") is turned off and Black Screen function is turned on, creating a black image. (See page 29.)</li> </ul>
Color is faded or poor.	<ul style="list-style-type: none"> <li>• The COLOR and TINT adjustments are not correct. (See page 26.)</li> </ul>
Picture is blurred.	<ul style="list-style-type: none"> <li>• Adjust the focus. (See page 9.)</li> <li>• The projection distance is too long or too short to allow for proper focus. (See page 10.)</li> </ul>
Picture appears but no sound is heard.	<ul style="list-style-type: none"> <li>• Cables improperly connected to side panel of the projector. (See pages 15, 16, 17, 18 and 19.)</li> <li>• Volume is set to minimum. (See page 25.)</li> </ul>
An unusual sound is occasionally heard from the cabinet.	<ul style="list-style-type: none"> <li>• If the picture is normal, the sound is due to cabinet shrinkage caused by temperature changes. This will not affect operation or performance.</li> </ul>
Maintenance indicator lights up.	<ul style="list-style-type: none"> <li>• Refer to "Lamp/Maintenance Indicators" on page 32.</li> </ul>

# Connection Pin Assignments

Analog RGB 1 Signal Input and Analog RGB 1 and 2 Output Terminal : 15-pin mini D-sub female connector

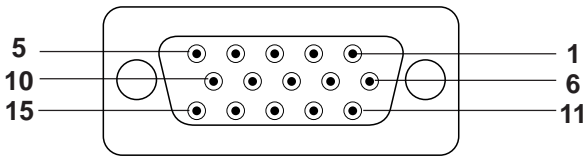

## Computer Input

Analog

- |                                      |                            |
|--------------------------------------|----------------------------|
| 1. Video input (red)                 | 8. Earth (blue)            |
| 2. Video input (green/sync on green) | 9. Not connected           |
| 3. Video input (blue)                | 10. GND                    |
| 4. Reserve input 1                   | 11. GND                    |
| 5. Composite sync                    | 12. Reserve input 2        |
| 6. Earth (red)                       | 13. Horizontal sync signal |
| 7. Earth (green/sync on green)       | 14. Vertical sync signal   |
|                                      | 15. Reserve input 3        |

Analog RGB 2 Signal Input : 5 BNC

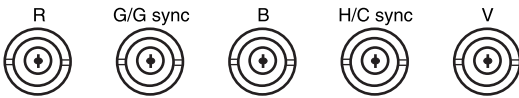

## Computer Input

Analog

- |          |   |
|----------|---|
| R        | Video input (red)                         |
| G/G sync | Video input (green/sync on green)         |
| B        | Video input (blue)                        |
| H/C sync | Horizontal sync signal, Mac C-sync signal |
| V        | Vertical sync signal                      |

Mouse Input Terminal (for IBM/Mac) : 9-pin D-sub female connector

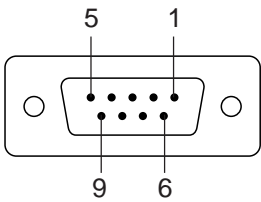

Pin No.	Signal	Name	I/O	Reference
1	CD	Carrier Detect	Input	Connected to internal circuit
2	RD	Receive Data	Input	Connected to internal circuit
3	SD	Send Data	Output	Connected to internal circuit
4	ER	Equipment Ready	Output	Connected to internal circuit
5	SG	Signal Ground		Connected to internal circuit
6	DR	Data Set Ready	Output	Not connected
7	RS	Request to Send	Output	Connected to internal circuit
8	CS	Clear to Send	Input	Connected to internal circuit
9	CI	Ring Indicator	Input	Connected to internal circuit

Mouse Input Terminal (for NEC PC98 series for Japan) : 9-pin mini DIN connector

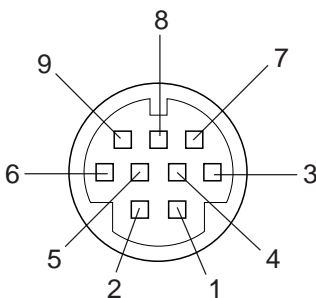

Pin No.	Signal	I/O	Reference
1	+5V	Input	Computer output
2	XA	Input	Computer output
3	XB	Input	Computer output
4	YA	Input	Computer output
5	YB	Input	Computer output
6	LEFT	Input	Computer output
7	NC	Input	Not connected
8	RIGHT	Input	Computer output
9	GND		Computer output

RS-232C terminal : 9-pin D-sub male connector

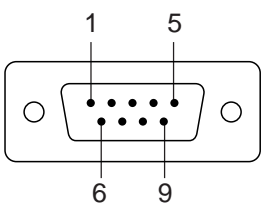

Pin No.	Signal	Name	I/O	Reference
1	CD			Not connected
2	RD	Receive Data	Input	Connected to internal circuit
3	SD	Send Data	Output	Connected to internal circuit
4	ER			Not connected
5	SG	Signal Ground		Connected to internal circuit
6	DR	Data Set Ready	Output	Not connected
7	RS	Request to Send	Output	Connected to internal circuit
8	CS			Not connected
9	CI			Not connected

# RS-232C Terminal Specifications

## 1. PC control

The personal computer can be used to control the projector by connecting the two via an RS-232C cable (cross type) (not supplied).

## 2. Communication conditions

Set the serial port settings of the computer to match that of the table below.

Signal format: Conforms to RS-232C standard.  
 Baud rate: 9,600 bps  
 Data length: 8 bits  
 Parity bit: NON  
 Stop bit: 1 bit  
 Flow control: None

## 3. Basic format

Commands from the computer are sent in the following order: command, parameter, and return code. After the unit processes the command from the computer, it sends a response code to the computer.

Command format

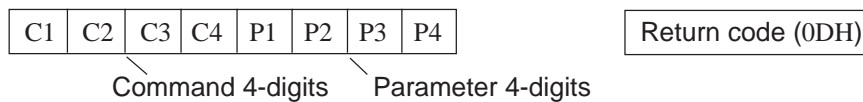

Response code format

Normal response



Problem response (communication error or incorrect command)



When more than one code is being sent, send each command only after the OK response code for the previous command from the unit is verified.

### Note:

- Using the computer control function of the unit, the liquid crystal projector conditions cannot be read to the computer. Therefore, confirm the conditions by transmitting the display commands for each adjustment menu and checking the conditions with the On-Screen Display. If the unit receives a command other than a menu display command, it will execute the command without displaying the On-Screen Display.

## 4. Commands

CONTROL ITEM	COMMAND				PARAMETER				CONTROL CONTENTS
	C1	C2	C3	C4	P1	P2	P3	P4	
POWER SETTING	P	O	W	R	--	--	--	0	POWER OFF
	P	O	W	R	--	--	--	1	POWER ON
INPUT SWITCHING	I	V	E	D	--	--	--	1	VIDEO 1
	I	V	E	D	--	--	--	2	VIDEO 2
	I	R	G	B	--	--	--	1	RGB 1
	I	R	G	B	--	--	--	2	RGB 2
INPUT CHECK	I	C	H	K	--	--	--	0	INPUT CHECK
	M	E	L	A	--	--	--	1	ENGLISH
LANGUAGE SELECTION	M	E	L	A	--	--	--	2	DEUTSCH
	M	E	L	A	--	--	--	3	ESPAÑOL
	M	E	L	A	--	--	--	4	NEDERLANDS
	M	E	L	A	--	--	--	5	FRANCAIS
	M	E	L	A	--	--	--	6	ITALIANO
	M	E	L	A	--	--	--	7	SVENSKA
VIDEO SYSTEM SELECTION	M	E	L	A	--	--	--	8	JAPANESE
	M	E	S	Y	--	--	--	1	AUTO
	M	E	S	Y	--	--	--	2	PAL
	M	E	S	Y	--	--	--	3	SECAM
VIDEO 1 IMAGE ADJUSTMENT	M	E	S	Y	--	--	--	4	NTSC 4.43
	M	E	S	Y	--	--	--	5	NTSC 3.58
	V	A	P	I	--	*	*	*	PICTURE (-30 ~ +30)
	V	A	B	R	--	*	*	*	BRIGHT (-30 ~ +30)
	V	A	C	O	--	*	*	*	COLOR (-30 ~ +30)
	V	A	T	I	--	*	*	*	TINT (-30 ~ +30)
	V	A	S	H	--	--	--	*	SHARPNESS (-30 ~ +30)
	V	A	R	E	--	--	--	0	VIDEO 1 DISPLAY
VIDEO 2 IMAGE ADJUSTMENT	V	A	R	E	--	--	--	1	RESET
	V	B	P	I	--	*	*	*	PICTURE (-30 ~ +30)
	V	B	B	R	--	*	*	*	BRIGHT (-30 ~ +30)
	V	B	C	O	--	*	*	*	COLOR (-30 ~ +30)
	V	B	T	I	--	*	*	*	TINT (-30 ~ +30)
	V	B	S	H	--	--	--	*	SHARPNESS (-30 ~ +30)
	V	B	R	E	--	--	--	0	VIDEO 2 DISPLAY
VIDEO BACKGROUND LEVEL	V	B	R	E	--	--	--	1	RESET
	W	B	R	D	--	*	*	*	RED (-30 ~ +30)
	W	B	B	E	--	*	*	*	BLUE (-30 ~ +30)

### Note:

- If a dash appears in the parameter column after a space. If an asterisk appears enter a value in the range indicated in brackets under CONTROL CONTENTS. See the examples on the next page.

CONTROL ITEM	COMMAND				PARAMETER				CONTROL CONTENTS	
	C1	C2	C3	C4	P1	P2	P3	P4		
VOLUME ADJUSTMENT	V	O	L	A	-	-	*	*	VOLUME (0 ~ 60)	
	M	U	T	E	-	-	-	0	MUTE OFF	
	M	U	T	E	-	-	-	1	MUTE ON	
AUDIO ADJUSTMENT	A	A	B	L	-	*	*	*	BALANCE (-30 ~ +30)	
	A	A	T	E	-	*	*	*	TREBLE (-30 ~ +30)	
	A	A	B	A	-	*	*	*	BASS (-30 ~ +30)	
	A	A	R	E	-	-	-	0	AUDIO DISPLAY	
	A	A	R	E	-	-	-	1	RESET	
	R	A	P	I	-	*	*	*	PICTURE (-30 ~ +30)	
RGB 1 ADJUSTMENT	R	A	B	R	-	*	*	*	BRIGHT (-30 ~ +30)	
	R	A	R	D	-	*	*	*	RED (-30 ~ +30)	
	R	A	B	E	-	*	*	*	BLUE (-30 ~ +30)	
	R	A	R	E	-	-	-	0	RGB DISPLAY	
	R	A	R	E	-	-	-	1	RESET	
	R	B	P	I	-	*	*	*	PICTURE (-30 ~ +30)	
RGB 2 ADJUSTMENT	R	B	B	R	-	*	*	*	BRIGHT (-30 ~ +30)	
	R	B	R	D	-	*	*	*	RED (-30 ~ +30)	
	R	B	B	E	-	*	*	*	BLUE (-30 ~ +30)	
	R	B	R	E	-	-	-	0	RGB DISPLAY	
	R	B	R	E	-	-	-	1	RESET	
	I	N	C	L	-	*	*	*	CLOCK (-60 ~ +60)	
RGB INPUT ADJUSTMENT	I	N	P	H	-	*	*	*	PHASE (-60 ~ +60)	
	I	A	H	P	-	*	*	*	H-POS (-60 ~ +60)	
	I	A	V	P	-	*	*	*	V-POS (-30 ~ +30)	
	I	A	R	E	-	-	-	0	RGB INPUT DISPLAY	
	I	A	R	E	-	-	-	1	RESET	
	L	N	F	O	-	*	*	*	LENS FOCUS (-30 ~ +30)	
SCREEN SETTING	L	N	Z	O	-	*	*	*	LENS ZOOM (-30 ~ +30)	
	L	N	S	H	-	*	*	*	LENS SHIFT (-30 ~ +30)	
	I	M	B	E	-	-	-	0	BLUE SCREEN OFF	
	I	M	B	E	-	-	-	1	BLUE SCREEN ON	
	I	M	B	K	-	-	-	0	BLACK SCREEN OFF	
	I	M	B	K	-	-	-	1	BLACK SCREEN ON	
	I	M	D	I	-	-	-	0	INPUT DISPLAY OFF	
	I	M	D	I	-	-	-	1	INPUT DISPLAY ON	
	I	M	R	E	-	-	-	0	REVERSE OFF	
	I	M	R	E	-	-	-	1	REVERSE ON	
	I	M	I	N	-	-	-	0	INVERT OFF	
	I	M	I	N	-	-	-	1	INVERT ON	
	VIDEO CONFIRMATION	S	Y	S	E	-	-	-	0	DISPLAY
	ON-SCREEN DISPLAY SETTING	I	M	B	O	-	-	-	0	BLACK SCREEN DISPLAY OFF
I		M	B	O	-	-	-	1	BLACK SCREEN DISPLAY ON	
MOUSE ADJUSTMENT	R	E	M	O	-	-	-	1	REMOTE MOUSE AT	
	R	E	M	O	-	-	-	2	REMOTE MOUSE 98	
DC 5V OUTPUT	D	C	5	V	-	-	-	0	WHEN LAMP IS ON	
	D	C	5	V	-	-	-	1	WHEN MAIN POWER IS ON	
SCREEN MODE MEMORY	M	E	M	A	-	-	-	0	MEMORY RELEASE	
	M	E	M	A	-	-	-	*	MEMORY SELECTION (1 ~ 7)	

**Notes:**

- RGB INPUT ADJUSTMENT can only be set in the displayed computer mode.
- The “- 30 ~ +30” values for Lens Focus, Lens Zoom and Lens Shift indicate the time required to set these functions to their minimum and maximum adjustment settings.

**Examples:**

For the RGB/VIDEO setting, select video and set the PAL mode.

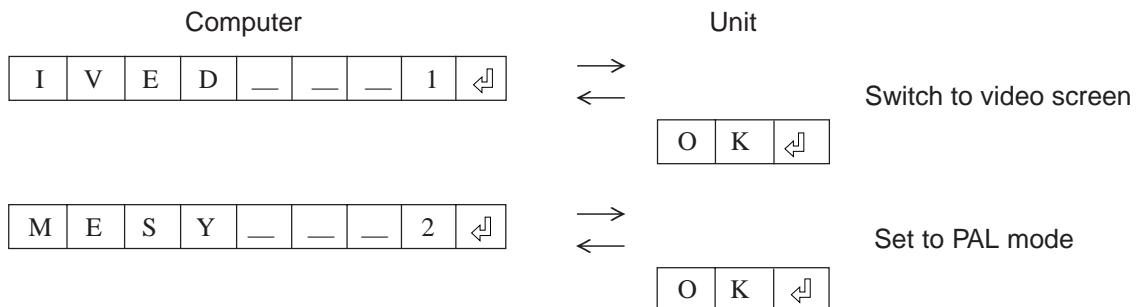

When BRIGHT of VIDEO IMAGE ADJUSTMENT is set to -10.

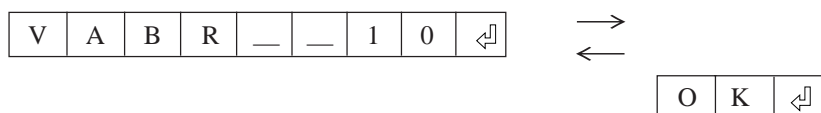

# Wired Remote Control Terminal Specifications

## 1. Specifications of wired remote control input

- 4.4ø minijack
- External: +5V (1A)
- Internal: GND

## 2. Function and transmission codes

No.	Control Item (Function)	System Code					Data Code					External Code				
		C1	C2	C3	C4	C5	C6	C7	C8	C9	C10	C11	C12	C13	C14	C15
1	VOLUME UP	1	0	1	1	0	0	0	1	0	1	0	0	0	1	0
2	VOLUME DOWN	1	0	1	1	0	1	0	1	0	1	0	0	0	1	0
3	POWER ON	1	0	1	1	0	0	1	1	0	1	0	1	0	1	0
4	POWER OFF	1	0	1	1	0	0	1	1	0	1	0	0	1	1	0
5	CURSOR UP ↑	1	0	1	1	0	0	0	1	1	1	0	0	1	1	0
6	CURSOR DOWN ↓	1	0	1	1	0	1	0	1	1	1	0	0	1	1	0
7	ADJUST UP →	1	0	1	1	0	1	1	1	1	0	0	1	0	1	0
8	ADJUST DOWN ←	1	0	1	1	0	0	0	0	0	1	0	1	0	1	0
9	MUTE	1	0	1	1	0	1	1	1	0	1	0	0	0	1	0
10	MENU	1	0	1	1	0	0	0	1	0	0	0	1	1	1	0
11	VIDEO 1	1	0	1	1	0	0	1	0	0	1	1	0	0	1	0
12	VIDEO 2	1	0	1	1	0	1	1	0	0	1	1	0	0	1	0
13	RGB1	1	0	1	1	0	1	0	1	0	1	1	0	0	1	0
14	RGB 2	1	0	1	1	0	0	1	1	0	1	1	0	0	1	0
15	ENTER	1	0	1	1	0	1	1	1	0	1	0	1	0	1	0
16	LENS SELECT	1	0	1	1	0	1	1	0	1	0	0	0	1	1	0
17	CHANNEL CALL	1	0	1	1	0	1	1	0	1	1	0	0	0	1	0
18	BLACK SCREEN	1	0	1	1	0	1	0	0	1	0	1	1	0	1	0

### Note:

- To operate the MOUSE, L-CLICK and R-CLICK functions through the wired remote control input, connect the cable from the wired remote control (supplied) terminal on the projector to the remote control. The codes for these functions are complex and are, therefore, not listed here.

Wired remote control function code

LSB

MSB

C1	System Code					C6	Data Code					C13	C14	C15
1	0	1	1	0	0	*	*	*	*	*	*	*	1	0

- \* System codes C1 to C5 are fixed at "10110".

- \* Codes C14 and C15 are reverse confirmation bits, with "10" indicating "Front" and "01" indicating "Rear".

## 3. Sharp remote control signal format

### 1) Transmission format

#### a) 15-bit format

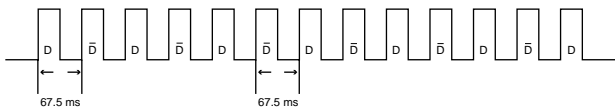

### 2) Wave form of output signal

- Output using Pulse Position Modulation

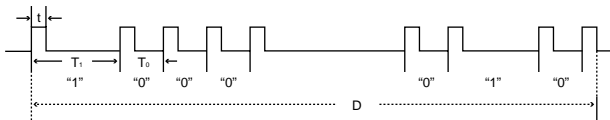

- $t = 264 \mu\text{s}$
- $T_o = 1.05 \text{ ms}$
- $T_1 = 2.10 \text{ ms}$
- Pulse carrier frequency = 455/12 kHz
- Duty ratio = 1:1

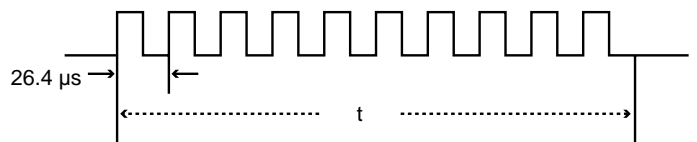

### 3) Transmission control code

#### a) 15 bit

C1	C2	C3	C4	C5	C6	C7	C8	C9	C10	C11	C12	C13	C14	C15
System Address					Function Key Data Bit					Data Expansion		Mask	Data Determination	
D to $\bar{D}$ Common Data Bit					Reverse in $\bar{D}$									

#### b) Example of Reverse D to $\bar{D}$

D	C1	C2	C3	C4	C5	C6	C7	C8	C9	C10	C11	C12	C13	C14	C15
	1	0	1	1	0	1	0	0	0	0	0	0	0	1	0

$\bar{D}$	C1	C2	C3	C4	C5	C6	C7	C8	C9	C10	C11	C12	C13	C14	C15
	1	0	1	1	0	0	1	1	1	1	1	1	1	0	1

# Specifications

Product Type	LCD Projector
Model	XG-E3500U
Video system	PAL/SECAM/NTSC 3.58/NTSC 4.43
Display method	LCD panel × 3, RGB optical shutter method
LCD panel	Panel size: 1.8" (27.6 [H] × 36.9 [W] mm) Display method: Translucent TN liquid crystal panel Drive method: TFT (Thin Film Transistor) Active Matrix panel No. of dots: 786,432 dots (1,024 [H] × 768 [V])
Lens	1–1.6 zoom lens, F2.5 to 3.5, f = 66 to 106 mm
Projection lamp	370 W Metal halide
Contrast ratio	100:1
Video input signal	BNC Connector: VIDEO, composite video, 1 Vp-p, sync negative, 75 Ω terminated RCA Connector: AUDIO, 0.5 Vrms more than 22 kΩ (stereo)
S-video input signal	4-pin mini DIN connector Y (luminance signal): 1 Vp-p, sync negative, 75 Ω terminated C (chrominance signal): Burst 0.286 Vp-p, 75 Ω terminated
Video (monitor) output signal	BNC Connector: VIDEO, composite video, 1Vp-p, sync negative, 75 Ω terminated RCA Connector: AUDIO, 0.5 Vrms less than 2.2 kΩ (stereo)
Horizontal resolution	520 TV lines (video input), 700 TV lines (S-video input)
Audio output	3 W + 3 W (stereo)
Computer RGB input signal	Video Signal: 15-pin mini D-sub connector (RGB 1), BNC connector (RGB 2): RGB separate/composite sync/sync on green type analog input: 0-0.7 Vp-p, positive, 75 Ω terminated Stereo Minijack: AUDIO, 0.5 Vrms, more than 22 kΩ (stereo)
RS-232C input terminal	9-pin D-sub male connector for controlling personal computer
Mouse input terminal (for IBM/Mac)	9-pin D-sub female connector for wireless mouse
Mouse input terminal (for PC98)	9-pin mini DIN connector for wireless mouse
Speaker system	3" (8 cm) round × 2
Rated voltage	AC 120 V
Rated frequency	50/60 Hz
Power consumption	535 W
Operating temperature	41°F to 104°F (+ 5°C to + 40°C)
Storage temperature	– 4°F to 140°F (– 20°C to + 60°C)
Cabinet	Plastic
I/R Carrier frequency	40 kHz
Laser Pointer of Remote Control	Wave length : 670 nm Max. output : 1 mW Class II Laser Product
Dimensions (W × D × H)	14.1" × 23.0" × 8.2" (359 × 585 × 208 mm) projector only 17.5" × 23.0" × 8.2" (444 × 585 × 208 mm) incl. terminal cover
Weight	36.3 lbs. (16.5 kg)
Supplied accessories	Remote control unit, Four AA batteries, Extra air filter, RGB signal cable (9.8', 3 m), Macintosh adaptor, Two BNC/RCA adaptors, Mouse control cable for IBM PS/2 (5.9", 15 cm), Mouse control cable for Mac (5.9", 15 cm), Mouse control cable (9.8', 3 m), AC cord, Terminal cover, Inverting labels, Lens cap (installed)
Replacement parts	Lamp unit (Lamp/cage module) (BQC-XGE3500U1), Remote control (RRMCG 1392CESA), Air filter (PFILD0082CEZZ), RGB signal cable (QCNW-4910CEZZ), Macintosh adaptor (QPLGJ1512CEZZ), Mouse control cable for IBM PS/2 (QCNW-4754CEZZ), Mouse control cable for Mac (QCNW-4755CEZZ), Mouse control cable (QCNW-4620CEZZ), AC cord (QACCU5013CEZZ)

Our projector uses LCD (Liquid Crystal Display) panels. These very sophisticated panels contain 786,432 pixels (× RGB) TFTs (Thin Film Transistors).

As with any high technology electronic equipment such as large screen TVs, video systems and/or video cameras, there are certain acceptable tolerances that the equipment must conform to. This unit has some inactive TFTs within acceptable tolerances, which may result in illuminated or inactive dots on the picture screen.

This will not affect the picture quality or the life expectancy of the unit.

If you have any questions about this matter, please call toll free 1-800-BE-SHARP (1-800-237-4277).

U.S.A. ONLY

*Specifications are subject to change without notice.*



# Dimensions

